

# PRODUCT SPECIFICATION

<b>Product P/N</b>	<b>3200/08</b>	<b>Mod. 984 Rev. 05</b>
<b>Description</b>	<b>Refill for EverFlo</b>	

**3200/08**

**Refill for EverFlo**

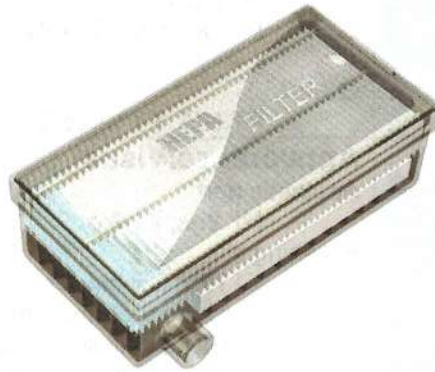

<b>PRODUCT DESCRIPTION</b>	<p>Inlet Connector: 12.7mm Ø straight connector          Approx. Dimensions: 121mm length x 60mm width x 48mm height          Weight: 58gm (approx.)          Unidirectional Filter</p> <p><b>Similar existing product:</b> <input type="checkbox"/> N/A <input checked="" type="checkbox"/> Specify: 3200 series filters</p>
<b>MANUFACTURER NAME</b>	<p><b>GVS Filter Technology UK</b>          NFC House          Vickers Industrial Estate          Mellishaw Lane, Morecambe          Lancashire LA3 3EN - United Kingdom</p> <p><b>Information</b>          Tel. +44 (0) 1524 847600          e-mail: gvsuk@gvs.com</p>
<b>INTENDED USE / APPLICATION</b>	Pre-filter for use within oxygen concentrator machines, to filter the air entering the device.
<b>CLASS OF THE PRODUCT</b>	Disposable medical device - Class 1 Annex V 93/42/EEC Rule 1 Annex VIII MDR 2017/745
<b>MATERIALS</b>	<p><b>Filter media:</b>  <input type="checkbox"/> N/A <input checked="" type="checkbox"/> Specify: Glass microfibre Media</p> <p><b>Frame/Housing Polymer:</b>  <input type="checkbox"/> N/A <input checked="" type="checkbox"/> Specify: Bronze Tinted Acrylonitrile Butadiene Styrene (ABS)</p> <p><b>Colour:</b>  <input type="checkbox"/> N/A <input checked="" type="checkbox"/> Specify: Bronze</p> <p><b>Other insert(s):</b>  <input type="checkbox"/> N/A <input checked="" type="checkbox"/> Specify: <b>Adhesive:</b> Polyolefin Hot Melt Adhesive</p> <p><b>Regulatory Documentation Required:</b>  <input checked="" type="checkbox"/> Biocompatibility according ISO 10993-1  <input type="checkbox"/> IMDS  <input checked="" type="checkbox"/> ROHS  <input checked="" type="checkbox"/> BSE/TSE</p>

# PRODUCT SPECIFICATION

<b>Product P/N</b>	<b>3200/08</b>	<b>Mod. 984 Rev. 05</b>
<b>Description</b>	<b>Refill for EverFlo</b>	

	<input checked="" type="checkbox"/> DEHP plasticizer Free and latex free <input checked="" type="checkbox"/> Aging <input checked="" type="checkbox"/> REACH <input checked="" type="checkbox"/> Conflict minerals  <b>Other:</b> <input checked="" type="checkbox"/> N/A <input type="checkbox"/> Specify:
<b>PRODUCT CHARACTERISTICS</b>	<b>Appearance/Visual</b> Aesthetic part: <input checked="" type="checkbox"/> Yes; <input type="checkbox"/> No Finishing: <input type="checkbox"/> Trim finishing mirror polished surfaces <input type="checkbox"/> Thin roughness surfaces <input type="checkbox"/> Gross roughness surface <input checked="" type="checkbox"/> As shown on drawing  Presence of graphics/Artwork: <input checked="" type="checkbox"/> No; <input type="checkbox"/> Specify:  Flash bears admitted: <input type="checkbox"/> N/A <input checked="" type="checkbox"/> Specify: Refer to the control plan.  Injection gate vestige: <input type="checkbox"/> N/A <input checked="" type="checkbox"/> Specify: Refer to the control plan.  Black spots admitted (size/area): <input type="checkbox"/> N/A <input checked="" type="checkbox"/> Specify: Refer to the control plan.  Infiltration into insert admitted: <input checked="" type="checkbox"/> N/A <input type="checkbox"/> Specify: Other: <input checked="" type="checkbox"/> N/A <input type="checkbox"/> Specify:  <b>Physical/Mechanical</b> Dimensions (Approx.): <b>121mm length x 60mm width x 48mm height</b> Weight: <b>58gm (approx.)</b> Interfaces (ex: Input / Output connectors): <input type="checkbox"/> N/A <input checked="" type="checkbox"/> Specify: <b>12.7mm Ø straight connector</b>  Operating temperature Range: <i>N/A</i> Storage temperature Range: <b>5 °C to 40 °C</b> Other: <input type="checkbox"/> N/A <input checked="" type="checkbox"/> Specify: <b>Unidirectional Filter</b>  <b>Chemical</b> Compatibility to solvents: <input checked="" type="checkbox"/> N/A <input type="checkbox"/> Specify: Resistance to weathering: <input checked="" type="checkbox"/> N/A <input type="checkbox"/> Specify: Other: <input checked="" type="checkbox"/> N/A <input type="checkbox"/> Specify:

# PRODUCT SPECIFICATION

<b>Product P/N</b>	<b>3200/08</b>	<b>Mod. 984 Rev. 05</b>
<b>Description</b>	<b>Refill for EverFlo</b>	

## Biological

Sterility:

N/A  Specify:

Pyrogenicity:

N/A  Specify:

Haemolysis:

N/A  Specify:

Toxicity:

N/A  Specify:

**Biocompatibility to ISO10993**

**Category – Surface device**

**Contact – Intact Skin**

**Contact Duration - <24hr**

## Functional

Air Flow Rate:

N/A  Specify: 30l/min, 60l/min, 90l/min

Water Break Through Pressure:

N/A  Specify:

Liquid Flow Rate:

N/A  Specify:

Bubble Point Pressure:

N/A  Specify:

Filtration Efficiency:

N/A  Specify:

**Filter Efficiency @ 30L/min using TSI 8130: Min. 99.4% (REP: 0607/15)**

Pressure Drop:

N/A  Specify:

**Flow Resistance @ 30L/min in accordance with EN ISO 9360-1: Max. 396Pa**

**Flow Resistance @ 60L/min in accordance with EN ISO 9360-1: Max. 1562Pa**

**Flow Resistance @ 90L/min in accordance with EN ISO 9360-1: Max. 3883Pa**

(REP: 0554/15 with 10% Factor of Safety applied to Max.)

Internal Volume:

N/A  Specify:

Operating Lifetime:

N/A  Specify: **Refer to Instructions for Use.**

Shelf Lifetime:

N/A  Specify: **5 years from the date of manufacture.**

Other:

N/A  Specify:

## Cleanliness

Part cleanliness:













# PRODUCT SPECIFICATION

<b>Product P/N</b>	<b>3200/08</b>	<b>Mod. 984 Rev. 05</b>
<b>Description</b>	<b>Refill for EverFlo</b>	

	<input checked="" type="checkbox"/> N/A <input type="checkbox"/> Specify: Clean-room Production required: <input type="checkbox"/> N/A <input checked="" type="checkbox"/> Specify: <b>Class 8</b> .  <b>Testing</b> Insert embedding Test: <input checked="" type="checkbox"/> N/A <input type="checkbox"/> Specify: Burst test: <input checked="" type="checkbox"/> N/A <input type="checkbox"/> Specify: Leakage: <input checked="" type="checkbox"/> N/A <input type="checkbox"/> Specify: Other: <input checked="" type="checkbox"/> N/A <input type="checkbox"/> Specify:
<b>INSTRUCTIONS / WARNINGS</b>	<b>IFU</b> <input type="checkbox"/> N/A <input checked="" type="checkbox"/> Required: Specify Languages: <input checked="" type="checkbox"/> English <input type="checkbox"/> French <input type="checkbox"/> Italian <input type="checkbox"/> Spanish <input type="checkbox"/> Portuguese <input type="checkbox"/> German <input type="checkbox"/> <input type="checkbox"/> Chinese <input type="checkbox"/> Japanese <input type="checkbox"/> Korean <input type="checkbox"/> Russian <input type="checkbox"/> Other (Specify):
<b>PRODUCT SHELF LIFE</b>	5 years from the date of manufacture.  <i>Expiration date and date of manufacture are detailed on the product labelling.</i>
<b>STERILIZATION</b>	<input checked="" type="checkbox"/> Not required; <input type="checkbox"/> EtO; <input type="checkbox"/> Gamma; <input type="checkbox"/> Beta; <input type="checkbox"/> Steam; <input type="checkbox"/> e-beam
<b>APPLICABLE STANDARDS AND REGULATIONS</b>	<b>Product Certification required:</b> <input checked="" type="checkbox"/> CE mark <input checked="" type="checkbox"/> FDA <input type="checkbox"/> Canadian Health <input type="checkbox"/> Brazil ANVISA <input type="checkbox"/> Argentina ANMAT <input type="checkbox"/> NIOSH <input type="checkbox"/> Japan <input type="checkbox"/> Korea <input type="checkbox"/> China <input type="checkbox"/> Russia <input type="checkbox"/> Other (Specify):  <b>Applicable Standards and Technical Regulations:</b> <i>Biological evaluation of Medical Devices - Part 1: Evaluation and Testing - ISO 10993-1.</i>  <i>Respiratory protective devices - Method for test - Part 7: Determination of particle filter penetration - BS EN 13274-7.</i>  <i>Medical devices- Application of risk management to medical devices - BS EN ISO 14971.</i>  <i>Medical devices – symbols to be used with medical device labels, labelling and information to be supplied - Part1: General requirements - ISO 15223-1.</i>  <b>Customer Specific Requirements: No</b>  <b>Is the Product a safety product?</b> <input type="checkbox"/> Yes <input checked="" type="checkbox"/> No

# PRODUCT SPECIFICATION

<b>Product P/N</b>	<b>3200/08</b>	<b>Mod. 984 Rev. 05</b>
<b>Description</b>	<b>Refill for EverFlo</b>	

	<p><b>Environment Impact:</b> Have atmosphere emissions, liquid effluents, underground leachables been considered?  <input checked="" type="checkbox"/> Yes <input type="checkbox"/> No</p> <p><b>Energy released (heat, vibration):</b>  <input type="checkbox"/> Yes <input checked="" type="checkbox"/> No</p>
<b>INTELLECTUAL PROPERTY AND FUNDING</b>	<p><b>Intellectual Property:</b> Patents that have been granted or applied for that must be considered.  <input checked="" type="checkbox"/> N/A <input type="checkbox"/> Specify:</p> <p><b>Grants:</b> Is the project (partially) funded by public institutions?  <input checked="" type="checkbox"/> N/A <input type="checkbox"/> Specify:</p>
<b>PACKAGING AND LABELING</b>	<p><b>Packaging</b>  <input checked="" type="checkbox"/> Primary: Refer to individual Part Numbers.  <input checked="" type="checkbox"/> Secondary: Refer to individual Part Numbers.</p> <p><b>Labelling:</b>  <input checked="" type="checkbox"/> Standard; <input type="checkbox"/> Customer specific:  <b>Primary packaging label</b></p> <div style="text-align: center;">  <p><b>Item Description</b></p> <div style="display: flex; justify-content: space-around;"> <div style="text-align: center;">                  </div> <div style="text-align: center;"> <div style="border: 1px solid black; border-radius: 15px; padding: 5px; width: 150px;"> <b>REF</b> XXXX/XXABCD001/0001         </div> <div style="border: 1px solid black; border-radius: 15px; padding: 5px; width: 150px; margin-top: 10px;"> <b>LOT</b> OL-XXXX/XXXXXX/21         </div> <div style="border: 1px solid black; border-radius: 15px; padding: 5px; width: 150px; margin-top: 10px;">  YYYY-MM-DD         </div> <div style="border: 1px solid black; border-radius: 15px; padding: 5px; width: 150px; margin-top: 10px;">  YYYY-MM-DD         </div> </div> </div> <p style="text-align: center;">  <b>GVS Filter Technology UK Ltd</b>          Morecambe, Lancashire, UK LA3 3EN  <a href="http://www.gvs.com">www.gvs.com</a> </p> <div style="text-align: center; border: 1px solid black; padding: 2px; width: fit-content; margin: 0 auto;"> <b>EC REP</b> GVS S.p.A. - <a href="http://www.gvs.com">www.gvs.com</a>          Via Roma, 50 - 40069 Zola Predosa ITALY       </div> <p style="text-align: right; font-size: small;">Re v 05A</p> </div>

Product P/N	3200/08	Mod. 984 Rev. 05
Description	Refill for EverFlo	

**Box label**

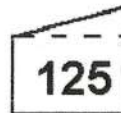

**Item description**



**REF** XXXX/XXABCD001/0001



**LOT** OL-XXXX/XXXXX/21



**Y**YYY-MM-DD



**Y**YYY-MM-DD



**GVS Filter Technology UK Ltd**  
Morecambe, Lancashire, UK LA3 3EN  
www.gvs.com Rev 09A



**EC REP** GVS S.p.A. - www.gvs.com  
Via Roma, 50 - 40069 Zola Predosa ITALY



12345678

**UDI:**

N/A;  No;  Yes (Specify):

*Number of pcs per bag is determined by the sales order.  
The first barcode label is applied to the outside of the bags.  
The second barcode label is applied onto the outside of the box.  
Each bag is labelled with the following traceability information:*

- ✓ Quantity
- ✓ Product description
- ✓ Product Date
- ✓ Lot Number (OL and 5 digit batch number to trace back to raw materials used)
- ✓ Operator Code

# PRODUCT SPECIFICATION

<b>Product P/N</b>	<b>3200/08</b>	<b>Mod. 984 Rev. 05</b>
<b>Description</b>	<b>Refill for EverFlo</b>	

<b>CERTIFICATE OF COMPLIANCE</b>	<p>With each shipment, GVS UK Customer Service will send the CofC to the Customer, based on the lot numbers and date of manufacture. Conformity declaration is printed on every invoice and Certificate is according to UNI EN 10204 type 2.1.</p> <p>The Quality management system is in compliance with ISO 9001, ISO 13485.</p>
----------------------------------	--

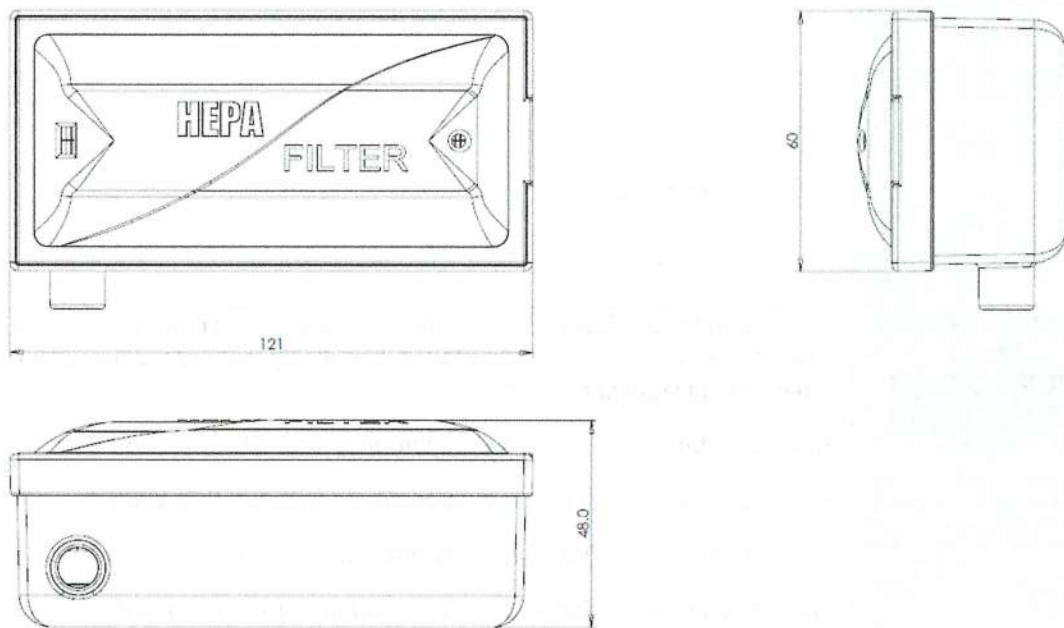
<b>DRAWING</b>	<p>The attached drawing is part of this product specification and must not be duplicated or made accessible to a third party without written permission from GVS Filter Technology UK Ltd.</p> 
----------------	--

<b>ACCEPTABLE QUALITY LEVEL</b>	<input checked="" type="checkbox"/> AQL: with sampling Plan: 0.65 AQL to ISO 2859-1 <input type="checkbox"/> PPM: <input type="checkbox"/> Other:
---------------------------------	---

<b>VISUAL REQUIREMENTS</b>	<p><b>Visual acceptance requirements apply when inspected under below conditions:</b></p> <p>Magnification: <i>Unaided eye at a distance of approximately 35-40cm.</i>          Light type: <i>Lighting level must be reasonable for visual detection.</i>          Timings: <i>Maximum inspection period per item is 25 seconds.</i>  <i>For detailed defect list, refer to product control plan.</i></p> <table border="1" style="width: 100%; border-collapse: collapse;"> <thead> <tr> <th colspan="2">Acceptance Requirement</th> <th>AQL</th> <th>Sampling Plan</th> </tr> </thead> <tbody> <tr> <td style="text-align: center;">1</td> <td>Black particle contamination</td> <td style="text-align: center;">0.65</td> <td rowspan="3" style="text-align: center; vertical-align: middle;">ISO 2859 Part 1 General Inspection Level 1</td> </tr> <tr> <td style="text-align: center;">2</td> <td>Damaged/broken item</td> <td style="text-align: center;">0.65</td> </tr> <tr> <td style="text-align: center;">3</td> <td>Blocked connector/luer</td> <td style="text-align: center;">0.65</td> </tr> </tbody> </table>	Acceptance Requirement		AQL	Sampling Plan	1	Black particle contamination	0.65	ISO 2859 Part 1 General Inspection Level 1	2	Damaged/broken item	0.65	3	Blocked connector/luer	0.65
Acceptance Requirement		AQL	Sampling Plan												
1	Black particle contamination	0.65	ISO 2859 Part 1 General Inspection Level 1												
2	Damaged/broken item	0.65													
3	Blocked connector/luer	0.65													

# PRODUCT SPECIFICATION

<b>Product P/N</b>	<b>3200/08</b>	<b>Mod. 984 Rev. 05</b>
<b>Description</b>	<b>Refill for EverFlo</b>	

	4	Weld marks	0.65
	5	Short fill moulding	0.65
	6	Rough surface or edges	0.65
	7	Pronounced injection gate	0.65
	8	Deformation/distortion	0.65
	9	Crack	0.65
	10	Oil/grease	0.65
	11	Wrong colour	0.65
	12	Weld fault	0.65

**GENERAL SAFETY  
AND  
PERFORMANCE  
REQUIREMENTS**

**Special characteristic:** Product characteristic which can affect safety or compliance with regulations, fit, function, performance or subsequent processing of product.

**Special Characteristic # 01:**

*Flow Resistance @ 30L/min in accordance with EN ISO 9360-1*

*Flow Resistance @ 60L/min in accordance with EN ISO 9360-1*

*Flow Resistance @ 90L/min in accordance with EN ISO 9360-1*

**Special Characteristic # 02:** Filter Efficiency @ 30L/min using TSI 8130 in accordance with EN 13274-7

This material specification describes the properties of product above indicated. This document contains general requirements, material description, drawing references, defect specification, biological material requirements.

## REVISIONS AND APPROVALS:

DATE	REV.	REASON FOR CHANGE	ISSUED AND CONTROLLED BY: (NAME/FUNCTION/SIGNATURE)	APPROVED BY: (NAME/FUNCTION/SIGNATURE)
28/01/2020	1	First Issue of Mod.984. Previous version available	Kinga Gawdzik – Engineering Support Technician 	Andrew Pearce – Quality Manager 





# PRODUCT SPECIFICATION

<b>Product P/N</b>	<b>3200/08</b>	<b>Mod. 984 Rev. 05</b>
<b>Description</b>	<b>Refill for EverFlo</b>	

## CUSTOMER APPROVAL:

We accept this material specification as a part of the agreed terms of delivery.

Company Name:

Approved by:

NAME/FUNCTION

SIGNATURE

DATE

COMPANY STAMP

*Please send back this document signed for approval. If we will not receive this specification signed, we consider the first order placed as implicit approval.*

