



SAMPLE PREPARATION PRODUCT COLLECTION



The GVS Group

In over 45 years of history, GVS has evolved from a supplier of components for the healthcare sector to a global group that produces highly technological diversified filtration solutions.

Wide range of products and custom design expertise

GVS produces a wide range of filter materials, filters and off-the-shelf components in all its divisions, enabling its customers to reduce the design time for new product launches.

All the GVS divisions work in highly regulated environments and the Group therefore operates with extremely high-quality standards. Thanks to its research and development centres located all over the world, GVS is also able to offer an extremely efficient and personalized service to meet its customers' needs: from product conception and design to testing and mass production.

Dynamic and flexible structure

GVS has developed a streamlined, dynamic and technologically advanced structure that has made it possible to achieve constant and balanced growth. The Group currently employs a total of 4869 people who work in automated assembly departments, in lines for the production and processing of filter membranes and in class 10,000 and 100,000 cleanrooms.

Global growth

The GVS Group has always paid great attention to research, development and innovation of its products and processes and has shown a strong trend towards development in global markets since its foundation.

In addition to the corporate headquarters in Bologna, GVS currently has 19 plants in Italy, United Kingdom, Brazil, United States, China, Mexico, Romania e Puerto Rico, and 29 commercial offices located all over the world. GVS has always adopted a "glocal" approach: it operates locally in contact with its customers, but relies on the strength of a global network.

For more information, visit www.gvs.com



Sample Preparation Index

Introduction.....	1
Syringeless Filters-SEPARA®	5
Syringe Filters-ABLUO®	7
ABLUO Supreme	11
Syringe Filter with Straw.....	13
Laboratory Syringes	14
Vacuum Filtration- EXTRACTO.....	17
Centrifuge Filters.....	22
Bottle-top Filters - ZapCap™.....	30
Extractor EtBr.....	31
Filter Holders.....	32
Micro-Filter Plates.....	34
Cannula Filter	36



Better performance for certain results

GVS Filter Technologies is constantly looking for new ways to expand our product offering to meet your needs and ease your application challenges. Our product innovations are the result of understanding your applications and valuing the amazing contributions your work can make to the quality of all our lives.

Whether you are pursuing goals in life science, pharmaceutical methods, research and development, quality control, or specialty environmental applications, we commit to not only deliver a product that works, but to look beyond what simply works and deliver a product that truly makes a difference.

GVS Filter Technologies is one of the few companies to offer a variety of products made from the same materials of construction, allowing for single- or multiple-sample processing of your techniques. We bring together membranes with superior performance, outstanding housing materials, and devices designed to maximize processing accuracy and speed.

Filter Media Selection has never been easy!

1. Consider Chemical Compatibility

Chemical compatibility is defined as the ability of a filter material to resist select chemicals so that the pore structure is not adversely affected by chemical exposure, and the filter material does not shed particles or fibers to add extractables. The chemical compatibility information on page 5 will help you make the right choice. Temperature, time, concentration, applied pressure, and length of exposure also affect compatibility.

Extractable Materials

The membrane manufacturer best prevents contaminants that elute from the filter media. GVS Filter Technologies specifically selects the highest grade of materials and performs rigorous extraction methods on our membrane products to reduce the occurrence of undesired artifacts. Choosing membranes that are compatible with your fluids and experimental conditions will reduce or eliminate extractables.

Binding

Membranes may chemically interact with the sample through electrostatic, ionic, covalent, hydrogen bonding, or other interactions. Binding can be a desirable or undesirable characteristic depending on the requirements of the application.

2. Consider Effective Filtration Area (EFA)

The particulate contained within a fluid affects the life of a filter. As particles are removed from a filter, they block pores and reduce the useable portion of the filter. Fluids with particulate loads will plug a filter more quickly than "clean" fluids. Increasing the EFA can lengthen the life of a filter. The Sample Volume Selection Guide on page 6 outlines general guidelines for the most appropriate filter size for different volumes of liquid.

3. Choose the Right Pore Size

Pore size is best selected by considering the instrumentation used for analysis. UV/V spectrophotometers may only require 1 μm filtration; HPLC analysis may require 0.45 μm filtration; and UHPLC will require 0.2 μm filtration due to the size of the column packing, beads, and internal frits. The filter material's pore size is determined by the diameter of the smallest particle that is to be retained with a defined, high degree of efficiency. For standard liquid chromatography systems using columns with 5 μm or larger packings, the filtration industry standard is 0.45 μm for syringe filters and mobile phase membranes.

For columns with packings smaller than 5 μm , UHPLC, microbore columns, or when concerned about microbial growth, a 0.2 μm filter is recommended. To clarify samples or when processing difficult-to-filter solutions, 1 to 5 μm pore sizes or glass fiber filters are suggested. Prefilters generally precede smaller pore size final filters and allow the user to process larger fluid volumes before the filter plugs.

Sample Preparation

The GVS Life Sciences Sample Preparation Family



GVS Life Sciences offers a range of disposable syringe filter devices designed to provide fast and efficient filtration of aqueous and organic solutions. They are available in a wide variety of sizes and membranes, with a polypropylene or acrylic housing, for both sterile and non sterile laboratory applications.



Features and Benefits

- Lower hold-up volume - due to an improved flow channel design and reduced spacing between the supports within the housing, for better handling of small sample volumes or costly samples
- Increased operating pressure - up to 80 psi due to the over-mold that prevents sample leaking at the seam and keeps the filter unit from bursting in half
- Strict quality control - syringe filters are integrity tested to ensure a proper fit and weld to eliminate any potential filter by pass
- Accurate labeling - each filter is labeled with the specific filter material and pore size for easy identification even if the syringe filter is not in its original packaging
- Multifunctional connectors - equipped with male luer-lock or male slip and female luer-lock connections
- Polypropylene or Acrylic housing
- Modified Acrylic housing to bidirectionally support the membrane allowing sample injection or aspiration
- Sterile or Non-Sterile options
- Bulk-packages or individual blisters
- Customized product and packaging on request
- Manufactured in the USA - GVS Life Sciences devices are manufactured in our ISO9001 certified plant in Sanford, Maine, USA, using proprietary microporous membranes from our plant in Westborough, Massachusetts, USA.

Products Selection Guide

HPLC Sample Preparation

Sample	Organic or Aqueous	Protein-Based Aqueous	Acid or Base Sample De-gassing	Aggressive acids and alcohols	Protein and Biological fluid	Organic sol-vents	
Detection Level / Filter Membrane	< 230 nm Nylon	< 230 nm Polypropylene	<230 nm Polypropylene	PTFE	PVDF	PES	RC
Sample Volume							
	<1mL	< 20 mL	< 100 mL	<1000			
Filter Device	Separa	Abluo 13	Abluo 33	Extracto	Abluo Supreme		

Pore Size

Filters come in a variety of pore sizes. The most common ones used in physical chemistry laboratories are 0.2 μm and 0.45 μm . Generally, 0.45 μm is sufficient for the majority of procedures. However, where smaller particles may be present in the sample 0.2 μm or 0.1 μm might be more appropriate. If you need to filter a smaller particle size (for example, to remove colloids) other types of filtration may be more appropriate

	Pore Sizes			
	0.1 μm	0.2 μm	0.45 μm	> 0.45 μm
Use	Sterilization	ICP-MS (trace metal analysis)	General analysis	Pre-filtration

Tissue Culture Media

Sample Preparation Products Selection Guide

	Presterilized Preparation Products	
Sample Concerns	Lowest Protein Binding	Higher throughput, Quicker Flow Rate
Filter Membrane	Cellulose Acetate	Polyethersulfone

Sample Volume Selection Guide

Volume	Product	Membrane Diameter	Filter	Housing	Pore Size (μm)	Sterile	Non Sterile
< 1 mL	Separa	N/A	Polytetrafluoroethylene		0,20, 0,45	No	Yes
			Regenerated Cellulose		0,20, 0,45	No	Yes
			Nylon 66	Polypropylene, PTFE and silicone	0,20, 0,45	No	Yes
			Polyvinylidene Fluoride	septa	0,20, 0,45	No	Yes
			Polyethersulfone		0,20, 0,45	No	Yes
< 12 mL	Abluo 13	13 mm	Cellulose Acetate	Acrylic	0,22 0,45 0,8 1,2 5,0	Yes	Yes
< 50 mL	Abluo 33	25 mm	Nylon 66	Acrylic	0,22 0,45 5,0	No	Yes
< 100 mL	Abluo Supreme	25 mm	Mixed Cellulose Esters	Polypropylene	0,22 0,45	No	Yes
			Polyethersulfone	Polypropylene	0,22 0,45	Yes	Yes
			Polytetrafluoroethylene Hydrophilic	Polypropylene	0,22 0,45	No	Yes
			Polytetrafluoroethylene	Polypropylene	0,22 0,45	No	Yes
			Regenerated Cellulose	Polypropylene	0,22 0,45	No	Yes
			Polyvinylidene Fluoride	Polypropylene	0,22 0,45	Yes	Yes
			Glass Fiber	Polypropylene	0,7 1,0 1,2 3,1	No	Yes
			< 150 mL	Extracto 150		Mixed Cellulose Esters	Polypropylene
< 250 mL	Extracto 250		Polyethersulfone	Polypropylene		Yes	No
< 500 mL	Extracto 500		Nylon 66	Polypropylene		Yes	No
< 1000 mL	Extracto 1000		Cellulose Acetate	Polypropylene		Yes	No
			Polyvinylidene Fluoride	Polypropylene		Yes	No
			Polyethersulfone High Flow	Polypropylene		Yes	No

Membrane Selection Guide

Cell and Particulate Analysis

Material	Code	Property	Features	Application
Cellulose Acetate	CA	Excellent flow rates. Very low protein binding, so they are suitable for protein recovery applications. Hydrophilic, so fine for aqueous and alcoholic media although they have limited solvent resistance. pH range -4-8.	<ul style="list-style-type: none"> Lowest Binding Material Available Highest Throughput Strength and Dimension Stability Uniform Pore Structure Hydrophilic 	<ul style="list-style-type: none"> Tissue Culture Media Sterilization Protein and Enzyme Filtration, Sterilization Biological Fluid Filtration, Sterilization Uniform Pore Structure Hydrophilic
Glass Micro-fibre	GMF	Chemically inert and available in higher pore sizes than other membranes. Mechanically extremely strong and tolerant to organic solvents. Not idea with strong acids (particularly hydrofluoric acid) or bases. Ideal for high particulates solutions, often used as a pre-filter before a membrane filter. Not a membrane filter and so has a slightly less exact retention efficiency than membranes. Will contribute extractables that interfere with ionic and metals analysis.	<ul style="list-style-type: none"> Biologically Inert Available With or Without Acrylic Binders High Dirt-Holding Capacity 	<ul style="list-style-type: none"> Gravimetric Analysis Prefilter to Extend Final Filter Life Clarification of Particulate Laden Solutions
Nitrocellulose	NC	High mechanical strength, high flow rates, and low extractable levels. A good choice for trace element analysis applications. High protein binding. pH range -4-8.	<ul style="list-style-type: none"> Consistent Flow Rates High Throughputs Uniform Pore Structure Hydrophilic 	<ul style="list-style-type: none"> Aqueous Filtration Microbiological Analysis Sterility Testing Gravimetric Analysis With Ashing Technique Particulate Analysis
Nylon	NY	Nylon membrane filters are hydrophilic, flexible, tear-resistant, and autoclavable. They are resistant to a range of organic solvents and suitable for use with high pH samples. Nylon binds proteins. Unsuitable for acidic solutions. pH range -3-14.	<ul style="list-style-type: none"> Naturally Hydrophilic Wide Chemical Compatibility Range Extremely Low Extractables Strength and Dimensional Stability Chemically and Biologically Inert Wide Chemical Compatibility Range Extremely Low Extractables Low Fiber Release More Defined Pore Size and Greater Retention Efficiency Than Glass Prefilters 	<ul style="list-style-type: none"> Sterilization, Clarification of Aqueous and Organic Solvent Solutions HPLC Sample Preparation
Polypropylene	PP	Slightly hydrophobic, can be used with a very wide range of solvents including aggressive hard-to-filter solutions such as strongly acidic samples. High and uniform tolerance to heat and mechanical stress. pH range -1-14.	<ul style="list-style-type: none"> Chemically and Biologically Inert Wide Chemical Compatibility Range Extremely Low Extractables Low Fiber Release More Defined Pore Size and Greater Retention Efficiency Than Glass Prefilters 	<ul style="list-style-type: none"> Sterilization, Clarification of Organic Solvent Solutions 0.1, 0.22, 0.45 27 HPLC Sample Preparation Prefilter to Extend Final Filter Life Final Filter for Noncritical Filtrations Prefiltering Solvents and Acids
Polyethersulfone	PES	Hydrophilic, stable in low pH, have low levels of extractables, and exhibit low protein binding, making them suitable for many aqueous and organic solvents. PES membranes allow higher liquid flow than PTFE. Temperature resistant. pH range -3-14 (sometimes quoted as 1-14).	<ul style="list-style-type: none"> Low Protein Binding Low Extractables Autoclavable Wide Chemical Compatibility Range Strength and Dimensional Stability High Flow Rates Excellent Sample Recovery Controlled Pore Structures 	<ul style="list-style-type: none"> Tissue Culture Media Sterilization Protein and Enzyme Filtration, Sterilization Biological Fluid Filtration, Sterilization Purify and Concentrate Proteins, Enzymes, Nucleic Acids and Antibodies Desalt
Polytetrafluoroethylene (Teflon)	PTFE	Is perfect for the filtration of gaseous or organic solvent-based samples and highly corrosive substances. Hydrophobic so provides chemical resistance to aggressive media and excellent temperature stability allowing an extended sampling range. If used with aqueous samples, the membrane usually requires pre-wetting (normally by using a small amount of alcohol). Can also be used to prevent moisture passing through air vents. pH range -1-14.	<ul style="list-style-type: none"> Naturally Hydrophobic Compatible with Strong Acids and aggressive Solvents Improved Durability and Handling Natural Hydrophobic Compatible with High Temperatures Chemically and Biologically Inert 	<ul style="list-style-type: none"> Filtration of Strong Acids and Aggressive Solvents Venting Applications Filtration of High Temperature Acids and Solvents
Polytetrafluoroethylene Hydrophilic (Teflon)	PTFE	PTFE provides device manufacturers with a consistent, temperature and chemical compatible barrier to microbes and particulate matter. The optimal combination of air flow and water entry pressure adds value to most device designs.	<ul style="list-style-type: none"> Naturally hydrophobic or hydrophilic Compatible with strong acids and aggressive solutions Improved durability and handling 	<ul style="list-style-type: none"> Filtration of strong acids and aggressive solutions Venting applications Phase separations Aerosol samplings
Rigenrated Cellulose	RC	Made from pure cellulose without wetting agents. Chemical resistance to a wide variety of solvents. High wet strength. Hydrophilic, so suitable for aqueous and organic samples. Very low protein binding capacity. pH range -3-12.	<ul style="list-style-type: none"> Hydrophilic Excellent chemical compatibility and resistance to organic solvents Low non-specific adsorption Superior thermal resistance High mechanical strength 	<ul style="list-style-type: none"> Filtration of Aqueous and Organic Solutions Particle removal from organic solvents or mixtures of aqueous and non-aqueous samples Ultra-cleaning and de-gassing solvents and mobile phases for HPLC Clarification Protein Chemistry
Polyvinylidene Fluoride	PVDF	Designed for high tensile strength, high solvent resistance, and low protein binding, making them suitable for biomedical filtration, sterilization filtration, and HPLC sample preparation. pH range -1-14.	<ul style="list-style-type: none"> Superior strength to withstand aggressive handling or use with automated equipment without breaking or tearing Low protein binding minimizes retention of proteins in solution Low extractables ensure tests will be clean with consistent results Lot-to-lot consistency ensures consistent flow and diffusion rates for dependable results every time 	<ul style="list-style-type: none"> Preparation of protein-containing solutions prior to chromatography or other instrument analyses. Useful for a wide range of applications, including aggressive and non-aggressive solvent-based mobile phase. Offers excellent chemical compatibility, even with aggressive acids and alcohols. Provides high flow rates and throughput, low extractables and broad chemical compatibility. Better protection of your analytical results.

Sample Preparation

Syringeless Filters - SEPARA®



Save time and money in sample preparation process with SEPARA® syringeless filters. The single step filtering process is efficient, simple to use, easy to press and fast.

Features and Benefits

- Rapid sample preparation
- Single step process, filtering with a plunger in the vial
- Sample ready to use after filtration
- Pre-slitted cap ensures easy and clean sample transfer
- Replace syringe, syringe filter, glass vial and cap
- Increase sample integrity with all-in vial and filter
- Compatible with most auto-samplers
- Compatible with most multi-compressors



Characteristics

Dimensions: 12 mm diameter x 32 mm height

Materials: Polypropylene, PTFE and Silicone septa

Fill Line Volume: 480 microliter

Filtering Capacity: 450 microliter

Dead Volume: 30 microliter

Compression Force: 8 psi (0.6 bar)

Maximum operating temperature: 120°F (50°C)

Housing options: amber for protection against photodegradation of light-sensitive samples, or translucent polypropylene (PP) for easy visual inspection.

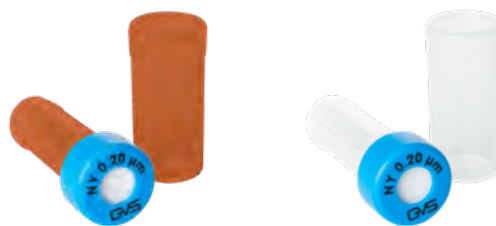
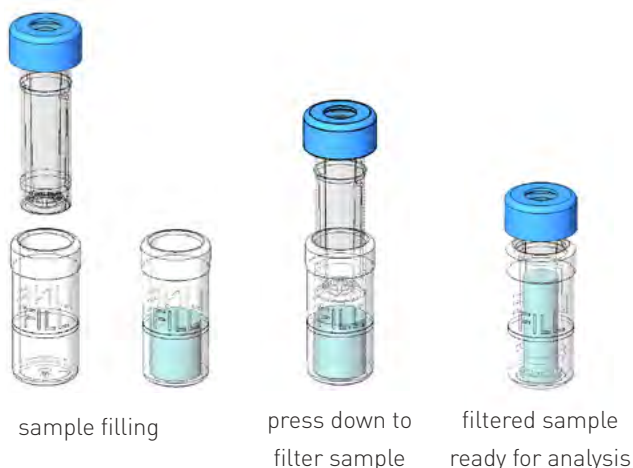

Ordering information

Membrane Material	Pore Size (µm)	Housing	Color	Product Code
				100/pk
Polytetrafluoroethylene (PTFE)	0.20	Translucent	Pink	MV32ANPPT002TC01
Polytetrafluoroethylene (PTFE)	0.45	Translucent	Red	MV32ANPPT004CC01
Regenerated Cellulose (RC)	0.20	Translucent	Gray	MV32ANPRC002GC01
Regenerated Cellulose (RC)	0.45	Translucent	Black	MV32ANPRC004LC01
Nylon (NY)	0.20	Translucent	Light Blue	MV32ANPNY002BC01
Nylon (NY)	0.45	Translucent	Blue	MV32ANPNY004UC01
Polyvinylidene Fluoride (PVDF)	0.20	Translucent	Yellow	MV32ANPPV002FC01
Polyvinylidene Fluoride (PVDF)	0.45	Translucent	Orange	MV32ANPPV004IC01
Polyethersulfone (PES)	0.20	Translucent	Light Green	MV32ANPPS002EC01
Polyethersulfone (PES)	0.45	Translucent	Dark Green	MV32ANPPS004WC01
Polytetrafluoroethylene (PTFE)*	0.20	Amber	Pink	MV32APUPT002TC01
Polytetrafluoroethylene (PTFE)*	0.45	Amber	Red	MV32APUPT004CC01
Regenerated Cellulose (RC)*	0.20	Amber	Gray	MV32APURC002GC01
Regenerated Cellulose (RC)*	0.45	Amber	Black	MV32APURC004LC01
Nylon (NY)*	0.20	Amber	Light Blue	MV32APUNY002BC01
Nylon (NY)*	0.45	Amber	Blue	MV32APUNY004UC01
Polyvinylidene Fluoride (PVDF)*	0.20	Amber	Yellow	MV32APUPV002FC01
Polyvinylidene Fluoride (PVDF)*	0.45	Amber	Orange	MV32APUPV004IC01
Polyethersulfone (PES)*	0.20	Amber	Light Green	MV32APUPS002EC01
Polyethersulfone (PES)*	0.45	Amber	Dark Green	MV32APUPS004WC01

Sample Preparation

Separa Syringeless Filter: Advantages

Save HPLC Sample Preparation Time & Preserve Precious Sample
Reduce Cross Contamination & Increase User Safety

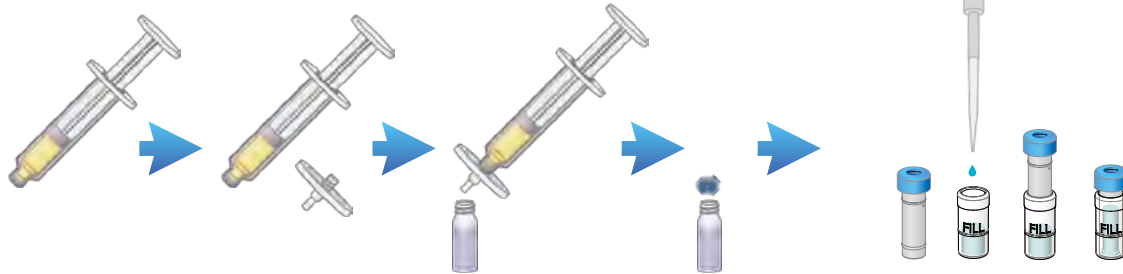

Save Purchasing Time & Cost On Consumables



Easy to Dispose & Save Time On Waste Management



Separa Toggler: Multi Vial Compressor

- ◆ Further shorten 30% sample preparation time
- ◆ Multiple filtration of 12 SEPARA® syringeless filter vial samples at a time
- ◆ Reduce user hand stress



SEPARA
TOGGLER

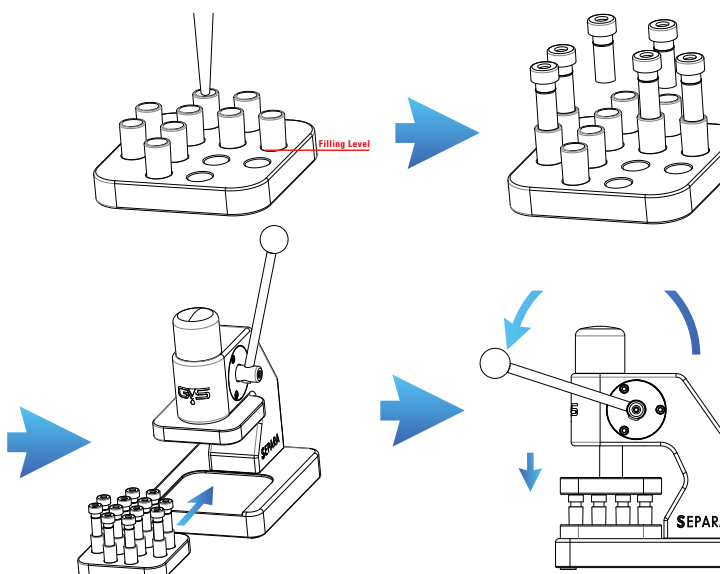

Description	Product Code 1/pk
Multi Vial Compressor	SEPARATOGGLER120

13 mm ABLUO® Syringe Filters



Characteristics

Membrane Materials: Cellulose Acetate, Nitrocellulose (MCE), Nylon 66, PES, PTFE, PVDF, Regenerated Cellulose

Membrane Diameter: 13 mm

Effective Filtration Area: 0.76 cm²

Housing Diameter: 18 mm

Housing Materials: Acrylic, Polypropylene, Ultrasonically welded

Inlet / Outlet: FLL / MLL-MLS

Holdup Volume: <50 microliter

Maximum Operating Temperature:

PP Abluo - 90°C / 194°F, Acrylic Abluo 50°C / 122°F

Maximum Operating Pressure: 80 psi

Sterile: No

Typical Applications

- ▲ Filtration of Aqueous, Organic and Alcohol Solutions
- ▲ Analytical Sample Preparation
- ▲ IC Chromatography
- ▲ Fuel Hydraulic Fluids and Machined Parts
- ▲ Clarification
- ▲ Protein Chemistry
- ▲ Cell Culture

Ordering information

Membrane Material	Pore Size (µ m)	End Fitting	Hosing Material	Color	Product Code	
					Packaging 100/ pk	Packaging 500/ pk
Cellulose Acetate (CA)	0.22	FLL/MLL	Acrylic	Blue	FJ13ANCCA002DH01	FJ13ANCCA002DD01
Cellulose Acetate (CA)	0.45	FLL/MLL	Acrylic	Yellow	FJ13ANCCA004FH01	FJ13ANCCA004FD01
Cellulose Acetate (CA)	0.80	FLL/MLL	Acrylic	Green	FJ13ANCCA008EH01	FJ13ANCCA008ED01
Cellulose Acetate (CA)	1.20	FLL/MLL	Acrylic	Red	FJ13ANCCA012CH01	FJ13ANCCA012CD01
Cellulose Acetate (CA)	5.00	FLL/MLL	Acrylic	Brown	FJ13ANCCA050PH01	FJ13ANCCA050PD01
Nylon 66 (NY)	0.22	FLL/MLS	Polypropylene	Transparent	FJ13BNPNY002AH01	FJ13BNPNY002AD01
Nylon 66 (NY)	0.45	FLL/MLS	Polypropylene	Transparent	FJ13BNPNY004AH01	FJ13BNPNY004AD01
Nylon 66 (NY)	5.00	FLL/MLL	Acrylic	Transparent	-	FJ13BNPNY050AD01
Polyethersulfone (PES)	0.22	FLL/MLS	Polypropylene	Transparent	FJ13BNPPS002AH01	FJ13BNPPS002AD01
Polyethersulfone (PES)	0.45	FLL/MLS	Polypropylene	Transparent	FJ13BNPPS004AH01	FJ13BNPPS004AD01
Mixed Cellulose Esters (MCE)	0.22	FLL/MLS	Polypropylene	Transparent	FJ13BNPNC002AH01	FJ13BNPNC002AD01
Mixed Cellulose Esters (MCE)	0.45	FLL/MLS	Polypropylene	Transparent	FJ13BNPNC004AH01	FJ13BNPNC004AD01
Regenerated Cellulose (RC)	0.22	FLL/MLS	Polypropylene	Transparent	FJ13BNPRC002AH01	FJ13BNPRC002AD01
Regenerated Cellulose (RC)	0.45	FLL/MLS	Polypropylene	Transparent	FJ13BNPRC004AH01	FJ13BNPRC004AD01
Polyvinylidene Fluoride (PVDF)	0.22	FLL/MLS	Polypropylene	Transparent	FJ13BNPPV002AH01	FJ13BNPPV002AD01
Polyvinylidene Fluoride (PVDF)	0.45	FLL/MLS	Polypropylene	Transparent	FJ13BNPPV004AH01	FJ13BNPPV004AD01
Polytetrafluoroethylene (PTFE)	0.22	FLL/MLS	Polypropylene	Transparent	FJ13BNPPT002AH01	FJ13BNPPT002AD01
Polytetrafluoroethylene (PTFE)	0.45	FLL/MLS	Polypropylene	Transparent	FJ13BNPPT004AH01	FJ13BNPPT004AD01
Polytetrafluoroethylene Hydrophilic (PTFE HP)	0.22	FLL/MLS	Polypropylene	Transparent	FJ13BNPPH002AH01	FJ13BNPPH002AD01
Polytetrafluoroethylene Hydrophilic (PTFE HP)	0.45	FLL/MLS	Polypropylene	Transparent	FJ13BNPPH004AH01	FJ13BNPPH004AD01

25 mm ABLUO® Syringe Filters



Characteristics

Membrane Materials: Cellulose Acetate, Glass Fiber, Nitrocellulose, Nylon 66, PES, Polyethylene, PTFE, PVDF, Regenerated Cellulose

Housing Diameter: 33 mm

Membrane Diameter: 25 mm

Effective Filtration Area: 4.6 cm²

Housing Materials: Acrylic, Polypropylene Ultrasonically welded

Inlet / Outlet: FLL / MLL-MLS

Holdup Volume: <100 microliter

Maximum Operating Temperature:

PP Abluo - 90°C / 194°F, Acrylic Abluo 50°C / 122°F

Maximum Operating Pressure: 80 psi

Sterile: No

Typical Applications

- Analytical sample preparation
- Biological fluids
- Buffer solutions
- Sterile filtering of tissue culture media
- Protein aqueous solutions
- Biofuel analysis
- HPLC sample preparation
- Pesticide testing
- Cannabis potency testing
- Neutraceutical sample preparation

Ordering information

Membrane Material	Pore Size (µm)	End Fitting	Housing Material	Color	Product Code	
					Packaging 100/pk	Packaging 500/pk
Cellulose Acetate (CA)	0.22	FLL/MLL	Acrylic	Blue	FJ25ANCCA002DH01	FJ25ANCCA002DD01
Cellulose Acetate (CA)	0.45	FLL/MLL	Acrylic	Yellow	FJ25ANCCA004FH01	FJ25ANCCA004FD01
Cellulose Acetate (CA)	0.80	FLL/MLL	Acrylic	Green	FJ25ANCCA008EH01	FJ25ANCCA008ED01
Cellulose Acetate (CA)	1.20	FLL/MLL	Acrylic	Red	FJ25ANCCA012CH01	FJ25ANCCA012CD01
Cellulose Acetate (CA)	5.00	FLL/MLL	Acrylic	Brown	FJ25ANCCA050PH01	FJ25ANCCA050PD01
Nylon 66 (NY)	0.22	FLL/MLS	Polypropylene	Transparent	FJ25BNPNY002AH01	FJ25BNPNY002AD01
Nylon 66 (NY)	0.45	FLL/MLS	Polypropylene	Transparent	FJ25BNPNY004AH01	FJ25BNPNY004AD01
Polyethersulfone (PES)	0.22	FLL/MLS	Polypropylene	Transparent	FJ25BNPPS002AH01	FJ25BNPPS002AD01
Polyethersulfone (PES)	0.45	FLL/MLS	Polypropylene	Transparent	FJ25BNPPS004AH01	FJ25BNPPS004AD01
Mixed Cellulose Esters (MCE)	0.22	FLL/MLS	Polypropylene	Transparent	FJ25BNPNC002AH01	FJ25BNPNC002AD01
Mixed Cellulose Esters (MCE)	0.45	FLL/MLS	Polypropylene	Transparent	FJ25BNPNC004AH01	FJ25BNPNC004AD01
Regenerated Cellulose (RC)	0.22	FLL/MLS	Polypropylene	Transparent	FJ25BNPRC002AH01	FJ25BNPRC002AD01
Regenerated Cellulose (RC)	0.45	FLL/MLS	Polypropylene	Transparent	FJ25BNPRC004AH01	FJ25BNPRC004AD01
Polyvinylidene Fluoride (PVDF)	0.22	FLL/MLS	Polypropylene	Transparent	FJ25BNPPV002AH01	FJ25BNPPV002AD01
Polyvinylidene Fluoride (PVDF)	0.45	FLL/MLS	Polypropylene	Transparent	FJ25BNPPV004AH01	FJ25BNPPV004AD01
Polytetrafluoroethylene (PTFE)	0.22	FLL/MLS	Polypropylene	Transparent	FJ25BNPPT002AH01	FJ25BNPPT002AD01
Polytetrafluoroethylene (PTFE)	0.45	FLL/MLS	Polypropylene	Transparent	FJ25BNPPT004AH01	FJ25BNPPT004AD01
Polytetrafluoroethylene Hydrophilic (PTFE HP)	0.22	FLL/MLS	Polypropylene	Transparent	FJ25BNPPH002AH01	FJ25BNPPH002AD01
Polytetrafluoroethylene Hydrophilic (PTFE HP)	0.45	FLL/MLS	Polypropylene	Transparent	FJ25BNPPH004AH01	FJ25BNPPH004AD01
Glass Fiber (GF)	0.70	FLL/MLS	Polypropylene	Transparent	FJ25BNPGF007AH01	FJ25BNPGF007AD01
Glass Fiber (GF)	1.00	FLL/MLS	Polypropylene	Transparent	FJ25BNPGF010AH01	FJ25BNPGF010AD01
Glass Fiber (GF)	1.20	FLL/MLS	Polypropylene	Transparent	FJ25BNPGF012AH01	FJ25BNPGF012AD01
Glass Fiber (GF)	3.10	FLL/MLS	Polypropylene	Transparent	FJ25BNPGF031AH01	FJ25BNPGF031AD01
Cellulose Acetate (CA)	0.22	FLL/MLS	Polypropylene	Transparent	-	FJ25BNPCA002AC17
Cellulose Acetate (CA)	0.45	FLL/MLS	Polypropylene	Transparent	-	FJ25BNPCA004AD01

13 mm STERILE ABLUO® Syringe Filters



Characteristics

Membrane Materials: Cellulose Acetate, PES, PVDF

Housing Diameter: 18 mm

Membrane Diameter: 13 mm

Effective Filtration Area: 0.76 cm²

Housing Material: Acrylic Ultrasonically welded

Inlet / Outlet: FLL / MLL-MLS

Holdup Volume: <50 microliter

Maximum Operating Temperature: 50°C / 122°F

Maximum Operating Pressure: 80 psi

Sterile: Yes

Typical Applications

- ◆ Filtration of Aqueous Solutions
- ◆ Analytical Sample Preparation
- ◆ IC Chromatography
- ◆ Sterile Filtration and Clarification
- ◆ Protein Chemistry
- ◆ Cell Culture
- ◆ Clarification

Ordering information

Membrane Material	Pore Size (μm)	End Fitting	Housing Material	Color	Product Code
					Packaging 50/pk
Cellulose Acetate (CA)	0.22	FLL/MLL	Acrylic	Blue	FJ13ASCCA002DL01
Cellulose Acetate (CA)	0.45	FLL/MLL	Acrylic	Yellow	FJ13ASCCA004FL01
Cellulose Acetate (CA)	0.80	FLL/MLL	Acrylic	Green	FJ13ASCCA008EL01
Cellulose Acetate (CA)	1.20	FLL/MLL	Acrylic	Red	FJ13ASCCA012CL01
Cellulose Acetate (CA)	5.00	FLL/MLL	Acrylic	Brown	FJ13ASCCA050PL01
Polyethersulfone (PES)	0.22	FLL/MLS	Acrylic	Transparent	FJ13BSCPS002AL01
Polyethersulfone (PES)	0.45	FLL/MLS	Acrylic	Transparent	FJ13BSCPS004AL01
Polyvinylidene Fluoride (PVDF)	0.22	FLL/MLS	Acrylic	Transparent	FJ13BSCPV002AL01
Polyvinylidene Fluoride (PVDF)	0.45	FLL/MLS	Acrylic	Transparent	FJ13BSCPV004AL01

25 mm STERILE ABLUO® Syringe Filters



Characteristics

- Membrane Materials:** Cellulose Acetate, Nylon 66, PES, PVDF
- Housing Diameter:** 33 mm
- Membrane Diameter:** 25 mm
- Housing Material:** Acrylic Ultrasonically welded
- Effective Filtration Area:** 4.6 cm²
- Inlet / Outlet:** FLL / MLL-MLS
- Holdup Volume:** <100 microliter
- Maximum Operating Temperature:** 50°C / 122°F
- Maximum Operating Pressure:** 80 psi
- Sterile:** Yes

Typical Applications

- ◆ Filtration of Aqueous and Alcohol Solutions
- ◆ Sterile Filtration and Clarification
- ◆ Cell Culture
- ◆ Analytical Sample Preparation
- ◆ IC Chromatography
- ◆ Clarification
- ◆ Protein Chemistry
- ◆ Filtration of Aqueous and Organic Solutions

Ordering information

Membrane Material	Pore Size (μm)	End Fitting	Housing Material	Color	Product Code
					Packaging 50/pk
Cellulose Acetate (CA)	0.22	FLL/MLS	Acrylic	Transparent	FJ25BSCCA002AL01
Cellulose Acetate (CA)	0.45	FLL/MLS	Acrylic	Transparent	FJ25BSCCA004AL01
Cellulose Acetate (CA)	0.80	FLL/MLS	Acrylic	Transparent	FJ25BSCCA008AL01
Cellulose Acetate (CA)	0.22	FLL/MLL	Acrylic	Blue	FJ25ASCCA002DL01
Cellulose Acetate (CA)	0.45	FLL/MLL	Acrylic	Yellow	FJ25ASCCA004FL01
Cellulose Acetate (CA)	0.80	FLL/MLL	Acrylic	Green	FJ25ASCCA008EL01
Cellulose Acetate (CA)	1.20	FLL/MLL	Acrylic	Red	FJ25ASCCA012CL01
Cellulose Acetate (CA)	5.00	FLL/MLL	Acrylic	Brown	FJ25ASCCA050PL01
Mixed Cellulose Esters (MCE)	0.22	FLL/MLS	Acrylic	Transparent	FJ25BSCNC002AL01
Mixed Cellulose Esters (MCE)	0.45	FLL/MLS	Acrylic	Transparent	FJ25BSCNC004AL01
Nylon 66 (NY)	0.10	FLL/MLS	Acrylic	Transparent	FJ25BSCNY001AL01
Nylon 66 (NY)	0.22	FLL/MLS	Acrylic	Transparent	FJ25BSCNY002AL01
Nylon 66 (NY)	0.45	FLL/MLS	Acrylic	Transparent	FJ25BSCNY004AL01
Nylon 66 (NY)	1.20	FLL/MLS	Acrylic	Transparent	FJ25BSCNY012AL01
Nylon 66 (NY)	5.00	FLL/MLS	Acrylic	Transparent	FJ25BSCNY050AL01
Polyethersulfone (PES)	0.80	FLL/MLS	Acrylic	Transparent	FJ25BSCPS008AL01
Polyethersulfone (PES)	0.22	FLL/MLS	Acrylic	Transparent	FJ25BSCPS002AL01
Polyethersulfone (PES)	0.45	FLL/MLS	Acrylic	Transparent	FJ25BSCPS004AL01
Polyvinylidene Fluoride (PVDF)	0.22	FLL/MLS	Acrylic	Transparent	FJ25BSCP002AL01
Polyvinylidene Fluoride (PVDF)	0.45	FLL/MLS	Acrylic	Transparent	FJ25BSCP004AL01

ABLU0 Supreme

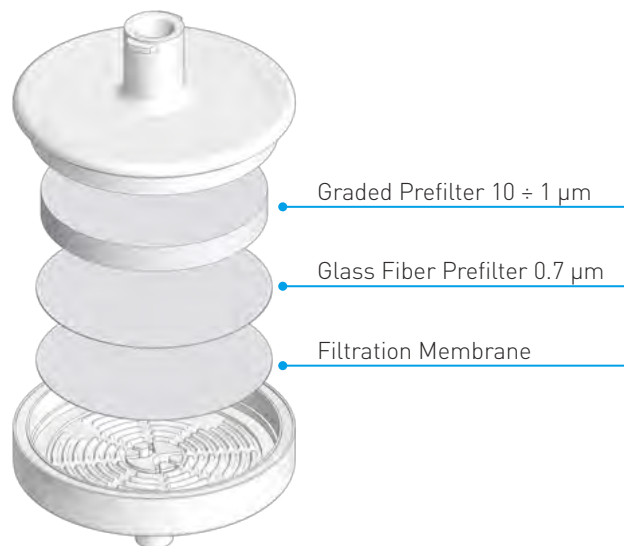
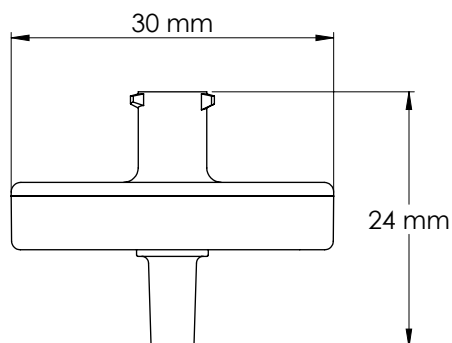

Characteristics

Membrane Diameter: 25 mm

Effective Filtration Area: 4.63 cm²

Housing Diameter: 30 mm

Housing Materials: Clear Polypropylene

Maximum Operating Temperature: 90°C / 194°F

Maximum Operating Pressure: 75 psi

Shelf Life (normal conditions): 3 years

Ordering information

Membrane Material	Pore Size (µm)	Description	Packaging	Product Code
NY	0.22	25MM FLL/MLS PP GF/F/NY 0.7/0.22µm	10/PK	GF25BNPGN002AT01
NY	0.22	25MM FLL/MLS PP GF/F/NY 0.7/0.22µm	50/PK	GF25BNPGN002AL01
NY	0.22	25MM FLL/MLS PP GF/F/NY 0.7/0.22µm	500/PK	GF25BNPGN002AD01
NY	0.45	25MM FLL/MLS PP GF/F/NY 0.7/0.45µm	10/PK	GF25BNPGN004AT01
NY	0.45	25MM FLL/MLS PP GF/F/NY 0.7/0.45µm	50/PK	GF25BNPGN004AL01
NY	0.45	25MM FLL/MLS PP GF/F/NY 0.7/0.45µm	500/PK	GF25BNPGN004AD01
PES	0.22	25MM FLL/MLS PP GF/F/PES 0.7/0.22µm	10/PK	GF25BNPGS002AT01
PES	0.22	25MM FLL/MLS PP GF/F/PES 0.7/0.22µm	50/PK	GF25BNPGS002AL01
PES	0.22	25MM FLL/MLS PP GF/F/PES 0.7/0.22µm	500/PK	GF25BNPGS002AD01
PES	0.45	25MM FLL/MLS PP GF/F/PES 0.7/0.45µm	10/PK	GF25BNPGS004AT01
PES	0.45	25MM FLL/MLS PP GF/F/PES 0.7/0.45µm	50/PK	GF25BNPGS004AL01
PES	0.45	25MM FLL/MLS PP GF/F/PES 0.7/0.45µm	500/PK	GF25BNPGS004AD01

Sample Preparation

Membrane Material	Pore Size (µm)	Description	Packaging	Product Code
PTFE	0.22	25MM FLL/MLS PP GF/F/PTFE 0.7/0.22µm	10/PK	GF25BNPGT002AT01
PTFE	0.22	25MM FLL/MLS PP GF/F/PTFE 0.7/0.22µm	50/PK	GF25BNPGT002AL01
PTFE	0.22	25MM FLL/MLS PP GF/F/PTFE 0.7/0.22µm	500/PK	GF25BNPGT002AD01
PTFE	0.45	25MM FLL/MLS PP GF/F/PTFE 0.7/0.45µm	10/PK	GF25BNPGT004AT01
PTFE	0.45	25MM FLL/MLS PP GF/F/PTFE 0.7/0.45µm	50/PK	GF25BNPGT004AL01
PTFE	0.45	25MM FLL/MLS PP GF/F/PTFE 0.7/0.45µm	500/PK	GF25BNPGT004AD01
PTFE (Hydrophilic)	0.22	25MM FLL/MLS PP GF/F/PTFE HYPHILIC 0.7/0.22µm	10/PK	GF25BNPGH002AT01
PTFE (Hydrophilic)	0.22	25MM FLL/MLS PP GF/F/PTFE HYPHILIC 0.7/0.22µm	50/PK	GF25BNPGH002AL01
PTFE (Hydrophilic)	0.22	25MM FLL/MLS PP GF/F/PTFE HYPHILIC 0.7/0.22µm	500/PK	GF25BNPGH002AD01
PTFE (Hydrophilic)	0.45	25MM FLL/MLS PP GF/F/PTFE HYPHILIC 0.7/0.45µm	10/PK	GF25BNPGH004AT01
PTFE (Hydrophilic)	0.45	25MM FLL/MLS PP GF/F/PTFE HYPHILIC 0.7/0.45µm	50/PK	GF25BNPGH004AL01
PTFE (Hydrophilic)	0.45	25MM FLL/MLS PP GF/F/PTFE HYPHILIC 0.7/0.45µm	500/PK	GF25BNPGH004AD01
PVDF	0.22	25MM FLL/MLS PP GF/F/PVDF 0.7/0.22µm	10/PK	GF25BNPGV002AT01
PVDF	0.22	25MM FLL/MLS PP GF/F/PVDF 0.7/0.22µm	50/PK	GF25BNPGV002AL01
PVDF	0.22	25MM FLL/MLS PP GF/F/PVDF 0.7/0.22µm	500/PK	GF25BNPGV002AD01
PVDF	0.45	25MM FLL/MLS PP GF/F/PVDF 0.7/0.45µm	10/PK	GF25BNPGV004AT01
PVDF	0.45	25MM FLL/MLS PP GF/F/PVDF 0.7/0.45µm	50/PK	GF25BNPGV004AL01
PVDF	0.45	25MM FLL/MLS PP GF/F/PVDF 0.7/0.45µm	500/PK	GF25BNPGV004AD01
RC	0.22	25MM FLL/MLS PP GF/F/RC 0.7/0.22µm	10/PK	GF25BNPGR002AT01
RC	0.22	25MM FLL/MLS PP GF/F/RC 0.7/0.22µm	50/PK	GF25BNPGR002AL01
RC	0.22	25MM FLL/MLS PP GF/F/RC 0.7/0.22µm	500/PK	GF25BNPGR002AD01
RC	0.45	25MM FLL/MLS PP GF/F/RC 0.7/0.45µm	10/PK	GF25BNPGR004AT01
RC	0.45	25MM FLL/MLS PP GF/F/RC 0.7/0.45µm	50/PK	GF25BNPGR004AL01
RC	0.45	25MM FLL/MLS PP GF/F/RC 0.7/0.45µm	500/PK	GF25BNPGR004AD01
CA	0.22	25MM FLL/MLS PP GF/F/CA 0.7/0.22µm	10/PK	GF25BNPGA002AT01
CA	0.22	25MM FLL/MLS PP GF/F/CA 0.7/0.22µm	50/PK	GF25BNPGA002AL01
CA	0.22	25MM FLL/MLS PP GF/F/CA 0.7/0.22µm	500/PK	GF25BNPGA002AD01
CA	0.45	25MM FLL/MLS PP GF/F/CA 0.7/0.45µm	10/PK	GF25BNPGA004AT01
CA	0.45	25MM FLL/MLS PP GF/F/CA 0.7/0.45µm	50/PK	GF25BNPGA004AL01
CA	0.45	25MM FLL/MLS PP GF/F/CA 0.7/0.45µm	500/PK	GF25BNPGA004AD01

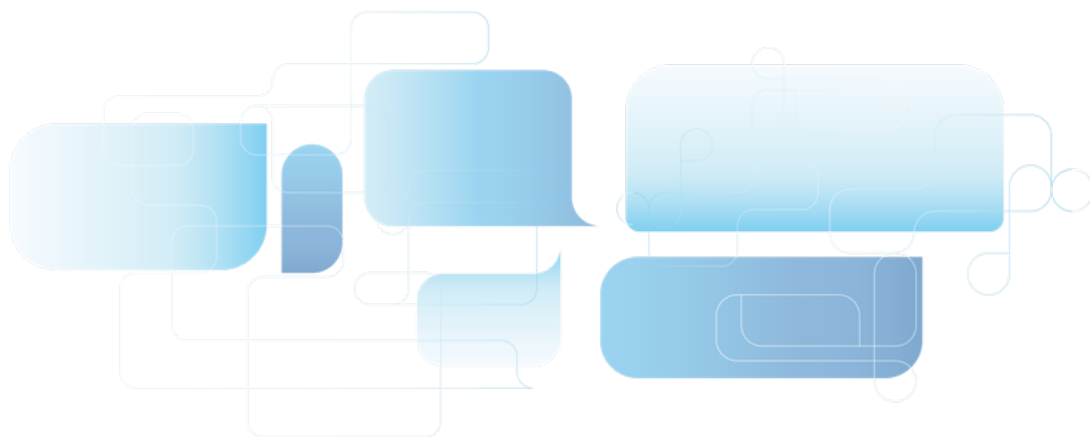

GVS Supreme Syringe Filter with Straw for ICP-MS Auto Sampler Integration



The GVS Supreme syringe filter with an integrated straw is specifically designed for ICP-MS (Inductively Coupled Plasma Mass Spectrometry) instruments. This multi-layer filter ensures effective sample preparation by removing particulates before they reach the ICP-MS, enhancing accuracy in elemental analysis. It offers superior filtration efficiency, high sample recovery, and is compatible with a variety of sample types including environmental, biological, and industrial samples.

Applications

- Environmental Monitoring: Routine environmental testing and soil analysis.
- Food and Beverage: Wine and drinking water analysis, and pesticide screening.
- Pharmaceutical and Biomedical Research: Pharmaceutical safety and trace metal analysis.
- Mining and Metals: Analysis of minerals like titanium dioxide and silicon dioxide.
- Geochemistry: Geochemical analysis and isotope mapping in rock samples.
- Clinical Research: Measuring trace elements in biological samples (e.g., iodine, copper, selenium).
- Semiconductor Manufacturing: Process and quality control in semiconductor production.
- Forensics: Analysis of glass and paint samples.

Why Choose GVS Supreme Syringe Filter with Straw?

- Superior Filtration: Multi-layer design enhances filtration efficiency, reducing contamination risks.
- Minimized Waste: The integrated straw reaches the bottom of sample containers, maximizing sample recovery.
- Instrument Protection: Prevents particulates from reaching the ICP-MS, protecting costly equipment.
- Seamless Integration: Designed to work seamlessly with auto samplers, ensuring a streamlined workflow.

Straw Features

Length of the Tube is 10cm

Materials: ABS, DEHP-Free PVC

Connection type: Luer lock



Sample Preparation

Laboratory Syringes Precision and Control for Accurate Lab Work

Reliable Syringes for Exact Liquid Handling



Key Features

- **Accurate Volume Control:** Available in various sizes: 1ml, 2ml, 3ml, 5ml, 10ml, 20ml, 30ml, 50ml, 60ml, ensuring precise liquid measurement.
- **Smooth Plunger Action:** High transparent PP material for tube and plunger. Designed for easy operation and smooth plunger movement, ensuring accurate fluid transfer with minimal force.
- **Durable Materials:** Manufactured with high-quality materials that resist chemical degradation, making them compatible with various solutions.
- **Leak-Proof Fit:** Available with luer lock or luer slip fittings to ensure secure connections, preventing leaks during liquid handling.
- **Sterile & Non-Sterile Options:** Choose between sterile syringes for critical applications or non-sterile options for general laboratory use.
- **Sterilization method:** Ethylene oxide

Our laboratory syringes are engineered for precision and control, offering reliable performance across a wide range of scientific applications. Whether you're measuring, transferring, or dispensing liquids, our syringes provide the accuracy and dependability required for your laboratory tasks.

**Parts: Barrel+Piston+Plunger; Latex-free, PVC-free
High transparent PP material for tube and plunger**

Applications

- **Sample Collection & Dispensing**
Ideal for precise liquid handling, ensuring accurate measurements and clean transfers for analysis.
- **Titration & Dosing**
Provides fine control over liquid flow, making it perfect for accurate titration and dosing in laboratory experiments.
- **Chemical Handling**
Excellent for handling corrosive chemicals and organic solvents due to the high compatibility of materials.
- **Cell Culture and Biological Applications**
Use sterile syringes to safely handle and dispense cell cultures, reagents, or biological fluids.

Why Choose Our Syringes?

- **Unmatched Precision:** Designed for accuracy and ease of use in every laboratory setting.
- **Wide Compatibility:** Suitable for a variety of solutions, including acids, bases, and solvents.
- **Safety and Reliability:** Built to meet the highest industry standards, ensuring consistent performance.

Ordering information

Product Code	Description	Packaging
SYRITG001LBP050A	1ml, Luer lock, Non Sterile, Bulk Pack	200 pcs/ pack, 50 packs/ case
SYRITG001LSP050A	1ml, Luer lock, Sterile, Bulk+Inner bag Pack	200 pcs/ pack, 50 packs/ case
SYRITG001LBP050B	1ml, Luer lock, Non Sterile, Bulk +Inner bag Pack+inner box	100 pcs/ pack, 48 packs/ case
SYRITG001LSP050B	1ml, Luer lock, Sterile, Bulk+Inner bag Pack+inner box	200 pcs/ pack, 16 packs/ case
SYRITG001LSB100A	1ml, Luer lock, Sterile, Individually Wrapped+inner box Pack	200 pcs/ pack, 16 packs/ case
SYRITG001SBP050A	1ml, Luer slip, Non Sterile, Bulk Pack	200 pcs/ pack, 50 packs/ case
SYRITG001SSP050A	1ml, Luer slip, Sterile, Bulk+Inner bag Pack	200 pcs/ pack, 50 packs/ case
SYRITG001SBP050B	1ml, Luer slip, Non Sterile, Bulk +Inner bag Pack+inner box	100 pcs/ pack, 48 packs/ case
SYRITG001SSP050B	1ml, Luer slip, Sterile, Bulk+Inner bag Pack+inner box	200 pcs/ pack, 16 packs/ case
SYRITG001SSB100A	1ml, Luer slip, Sterile, Individually Wrapped+inner box Pack	200 pcs/ pack, 16 packs/ case
SYRITG002LBP050A	2ml, Luer lock, Non Sterile, Bulk Pack	200 pcs/ pack, 25 packs/ case
SYRITG002LSP050A	2ml, Luer lock, Sterile, Bulk+Inner bag Pack	200 pcs/ pack, 25 packs/ case
SYRITG002LBP050B	2ml, Luer lock, Non Sterile, Bulk Pack +Inner bag Pack+inner box	200 pcs/ pack, 25 packs/ case
SYRITG002LSP050B	2ml, Luer lock, Sterile, Bulk+Inner bag Pack+inner box	200 pcs/ pack, 25 packs/ case
SYRITG002LSB100A	2ml, Luer lock, Sterile, Individually Wrapped+inner box Pack	200 pcs/ pack, 15 packs/ case

Sample Preparation

Product Code	Description	Packaging
SYRITG002SSP050A	2ml, Luer slip, Sterile, Bulk+Inner bag Pack	200 pcs/ pack, 25 packs/ case
SYRITG002SBP050A	2ml, Luer slip, Non Sterile, Bulk Pack	200 pcs/ pack, 25 packs/ case
SYRITG002SBP050B	2ml, Luer slip, Non Sterile, Bulk Pack+Inner bag Pack+inner box	200 pcs/ pack, 25 packs/ case
SYRITG002SSP050B	2ml, Luer slip, Sterile, Bulk+Inner bag Pack+inner box	200 pcs/ pack, 25 packs/ case
SYRITG002SSB100A	2ml, Luer slip, Sterile, Individually Wrapped+innber box Pack	200 pcs/ pack, 15 packs/ case
SYRITG003LBP050A	3ml, Luer lock, Non Sterile, Bulk Pack	200 pcs/ pack, 25 packs/ case
SYRITG003LSP050A	3ml, Luer lock, Sterile, Bulk+Inner bag Pack	200 pcs/ pack, 25 packs/ case
SYRITG003LBP050B	3ml, Luer lock, Non Sterile, Bulk Pack+Inner bag Pack+inner box	200 pcs/ pack, 25 packs/ case
SYRITG003LSP050B	3ml, Luer lock, Sterile, Bulk+Inner bag Pack+inner box	200 pcs/ pack, 25 packs/ case
SYRITG003LSB100A	3ml, Luer lock, Sterile, Individually Wrapped+innber box Pack	200 pcs/ pack, 15 packs/ case
SYRITG003SBP050A	3ml, Luer slip, Non Sterile, Bulk Pack	200 pcs/ pack, 25 packs/ case
SYRITG003SSP050A	3ml, Luer slip, Sterile, Bulk+Inner bag Pack	200 pcs/ pack, 25 packs/ case
SYRITG003SBP050B	3ml, Luer slip, Non Sterile, Bulk Pack+Inner bag Pack+inner box	200 pcs/ pack, 25 packs/ case
SYRITG003SSP050B	3ml, Luer slip, Sterile, Bulk+Inner bag Pack+inner box	200 pcs/ pack, 25 packs/ case
SYRITG003SSB100A	3ml, Luer slip, Sterile, Individually Wrapped+innber box Pack	200 pcs/ pack, 15 packs/ case
SYRITG005LBP050A	5ml, Luer lock, Non Sterile, Bulk Pack	100 pcs/ pack, 40 packs/ case
SYRITG005LSP050A	5ml, Luer lock, Sterile, Bulk+Inner bag Pack	100 pcs/ pack, 40 packs/ case
SYRITG005LBP050B	5ml, Luer lock, Non Sterile, Bulk+Inner bag Pack+inner box	100 pcs/ pack, 32 packs/ case
SYRITG005LSP050B	5ml, Luer lock, Sterile, Bulk+Inner bag Pack+inner box	100 pcs/ pack, 24 packs/ case
SYRITG005LSB100A	5ml, Luer lock, Sterile, Individually Wrapped+innber box Pack	100 pcs/ pack, 24 packs/ case
SYRITG005SBP050A	5ml, Luer slip, Non Sterile, Bulk Pack	100 pcs/ pack, 40 packs/ case
SYRITG005SSP050A	5ml, Luer slip, Sterile, Bulk+Inner bag Pack	100 pcs/ pack, 40 packs/ case
SYRITG005SBP050B	5ml, Luer slip, Non Sterile, Bulk+Inner bag Pack+inner box	100 pcs/ pack, 32 packs/ case
SYRITG005SSP050B	5ml, Luer slip, Sterile, Bulk+Inner bag Pack+inner box	100 pcs/ pack, 24 packs/ case
SYRITG005SSB100A	5ml, Luer slip, Sterile, Individually Wrapped+innber box Pack	100 pcs/ pack, 24 packs/ case
SYRITG010LBP050A	10ml, Luer lock, Non Sterile, Bulk Pack	100 pcs/ pack, 25 packs/ case
SYRITG010LSP050A	10ml, Luer lock, Sterile, Bulk+Inner bag Pack	100 pcs/ pack, 25 packs/ case
SYRITG010LBP050B	10ml, Luer lock, Non Sterile, Bulk Pack+Inner bag Pack+inner box	100 pcs/ pack, 25 packs/ case
SYRITG010LSP050B	10ml, Luer lock, Sterile, Bulk+Inner bag Pack+inner box	100 pcs/ pack, 25 packs/ case
SYRITG010LSB100A	10ml, Luer lock, Sterile, Individually Wrapped+innber box Pack	100 pcs/ pack, 16 packs/ case
SYRITG010SBP050A	10ml, Luer slip, Non Sterile, Bulk Pack	100 pcs/ pack, 25 packs/ case
SYRITG010SSP050A	10ml, Luer slip, Sterile, Bulk+Inner bag Pack	100 pcs/ pack, 25 packs/ case
SYRITG010SBP050B	10ml, Luer slip, Non Sterile, Bulk Pack+Inner bag Pack+inner box	100 pcs/ pack, 25 packs/ case
SYRITG010SSP050B	10ml, Luer slip, Sterile, Bulk+Inner bag Pack+inner box	100 pcs/ pack, 25 packs/ case
SYRITG010SSB100A	10ml, Luer slip, Sterile, Individually Wrapped+innber box Pack	100 pcs/ pack, 16 packs/ case
SYRITG020LBP050A	20ml, Luer lock, Non Sterile, Bulk Pack	100 pcs/ pack, 12 packs/ case
SYRITG020LSP050A	20ml, Luer lock, Sterile, Bulk+Inner bag Pack	100 pcs/ pack, 12 packs/ case
SYRITG020LBP050B	20ml, Luer lock, Non Sterile, Bulk Pack+Inner bag Pack+inner box	100 pcs/ pack, 12 packs/ case
SYRITG020LSP050B	20ml, Luer lock, Sterile, Bulk+Inner bag Pack+inner box	100 pcs/ pack, 12 packs/ case
SYRITG020LSB100A	20ml, Luer lock, Sterile, Individually Wrapped+innber box Pack	100 pcs/ pack, 8 packs/ case
SYRITG020SBP050A	20ml, Luer slip, Non Sterile, Bulk Pack	100 pcs/ pack, 12 packs/ case
SYRITG020SSP050A	20ml, Luer slip, Sterile, Bulk+Inner bag Pack	100 pcs/ pack, 12 packs/ case
SYRITG020SBP050B	20ml, Luer slip, Non Sterile, Bulk Pack+Inner bag Pack+inner box	100 pcs/ pack, 12 packs/ case
SYRITG020SSP050B	20ml, Luer slip, Sterile, Bulk+Inner bag Pack+inner box	100 pcs/ pack, 12 packs/ case
SYRITG020SSB100A	20ml, Luer slip, Sterile, Individually Wrapped+innber box Pack	100 pcs/ pack, 8 packs/ case
SYRITG050LBP050A	50ml, Luer lock, Non Sterile, Bulk Pack	50 pcs/ pack, 10 packs/ case
SYRITG050LSP050A	50ml, Luer lock, Sterile, Bulk+Inner bag Pack	50 pcs/ pack, 10 packs/ case
SYRITG050LBP050B	50ml, Luer lock, Non Sterile, Bulk Pack+Inner bag Pack+inner box	50 pcs/ pack, 10 packs/ case
SYRITG050LSP050B	50ml, Luer lock, Sterile, Bulk+Inner bag Pack+inner box	50 pcs/ pack, 10 packs/ case
SYRITG050LSB025A	50ml, Luer lock, Sterile, Individually Wrapped+innber box Pack	50 pcs/ pack, 8 packs/ case
SYRITG050SBP050A	50ml, Luer slip, Non Sterile, Bulk Pack	50 pcs/ pack, 10 packs/ case
SYRITG050SSP050A	50ml, Luer slip, Sterile, Bulk+Inner bag Pack	50 pcs/ pack, 10 packs/ case
SYRITG050SBP050B	50ml, Luer slip, Non Sterile, Bulk Pack+Inner bag Pack+inner box	50 pcs/ pack, 10 packs/ case
SYRITG050SSP050B	50ml, Luer slip, Sterile, Bulk+Inner bag Pack+inner box	50 pcs/ pack, 10 packs/ case
SYRITG050SSB025A	50ml, Luer slip, Sterile, Individually Wrapped+innber box Pack	50 pcs/ pack, 8 packs/ case

Disposable 2-part Syringe without Needle



It is used to extract the liquid and mixed liquid and it is not for human body injection use.

Material: High transparent medical grade PP(barrel), PE(plunger)

Features

- Transparent, bright appearance
- Non-toxic, Non-pyrogenic
- High level sealing, smooth sliding
- High-quality silicide process

Ordering information

Product Code	Description
SYRITGWOST02LSBA	2 pieces disposable syringe,2 ML (3 ML) Luer slip CENTRIC bulk
SYRITGWOST05LLBA	2 pieces disposable syringe,5 ML (6 ML) Luer centric bulk
SYRITGWOST10LLBA	2 pieces disposable syringe,10 ML (12 ML) Luer bulk
SYRITGWOST20LLBA	2 pieces disposable syringe,20 ML (24 ML) Luer bulk
SYRITGWOST02LSSA	2 pieces disposable syringe,2 ML (3 ML) Luer slip CENTRIC sterile EO
SYRITGWOST05LLSA	2 pieces disposable syringe,5 ML (6 ML) Luer centric sterileEO
SYRITGWOST10LLSA	2 pieces disposable syringe,10 ML (12 ML) Luer sterileEO
SYRITGWOST20LLSA	2 pieces disposable syringe,20 ML (24 ML) Luer sterileEO

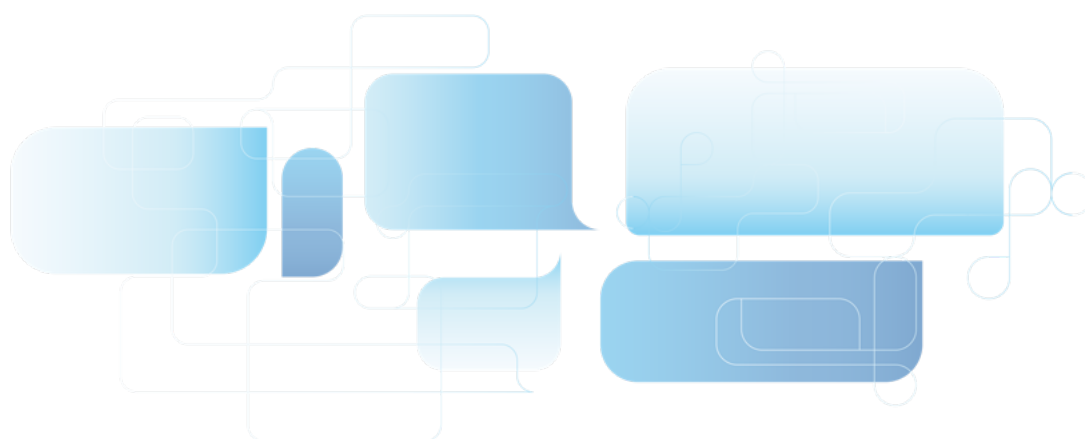

Vacuum Filtration



GVS Vacuum Filters are very useful in large volume samples separation and purification.

Characteristics

- Available with 5 membrane sorts of PVDF, PES, MCE, Nylon and CA
- 3 membrane pore sizes of 0.10 µm, 0.22 µm and 0.45 µm
- 4 volumes size of 150, 250, 500 and 1000 ml
- Light weight and heavy wall construction
- Large knurls on the reservoir bottle cap for easy screw
- Designed wide and easy access bottle mouth for efficiently and stably pour out
- Engraved graduation ensure veracity
- Ergonomically designed sidewalls and collar can simplify tightening /loosening and adjustments
- Designed hose connector can fit multiplicate hose diameters
- Non-pyrogenic
- Gamma irradiation sterilized

Features

- Vacuum packaged in easy tear-to-open plastic bag and receiver bottle cap is individually wrapped
- Each individual unit is lot-numbered for easy identification and tracking

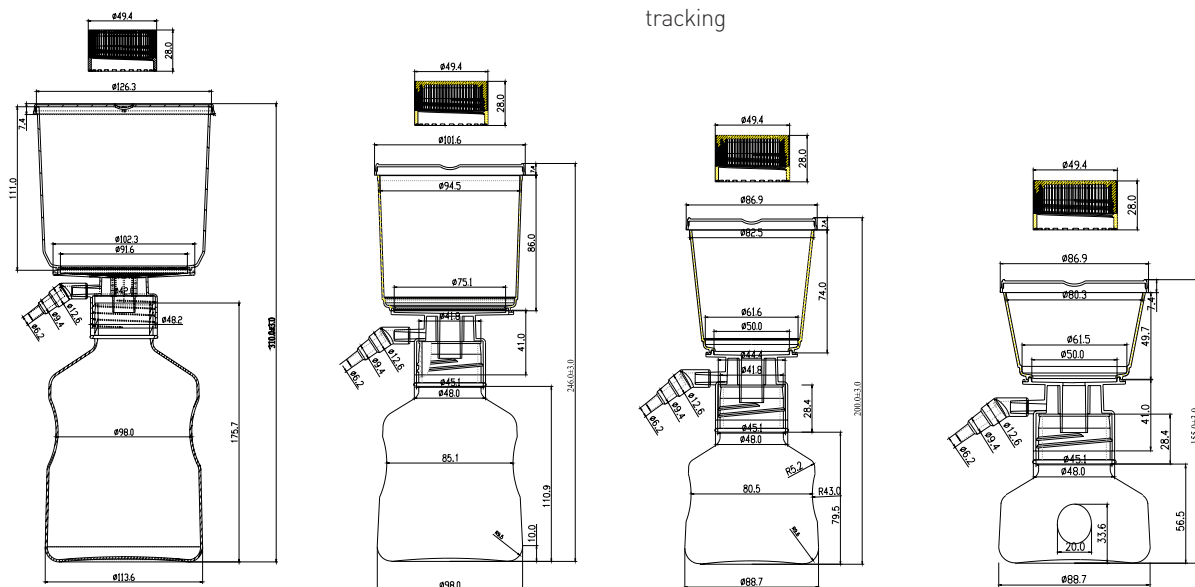

Housing Material	Capacity (ml)	Full Unit Overall Height (mm)	Filter Diameter (mm)	Working Volume (mm)	Hold-up Volume (ml)	Linker and Cap Material	Fitting Outlet (mm)	Maximum Operating Temperature (°C)
ABS	150	156	50	150	3	PP	45	45
ABS	250	200	50	250	3	PP	45	45
ABS	500	500	75	500	3	PP	45	45
ABS	1000	1000	91	1000	3	PP	45	45

Sample Preparation

Disposable Filtration Products

GVS Laboratory Filtration Products series, including syringe filters and Vacuum Filters, are designed specifically for the filtration of culture media and organic solvents in research and industrial laboratories. They are purpose-built with features designed to bring the highest levels of performance and purity to your research. A variety of membrane types and membrane areas are for choice that offer the wide applicability range for separation and purification of most liquid samples to meet different laboratory needs. The filtration products should be driven by syringes or vacuum pumps. All the products are manufactured with high quality material [Acrylonitrile butadiene styrene (ABS), Polypropylene (PP) or Polystyrene (GPPS)] and by proven technique, which assure them work under pressure and still hold integrity.

Tips on choosing membrane MCE (Mixed Cellulose Ester)

By the mixture of nitrocellulose and cellulose acetate, hydrophilic, chemical compatibility, low protein adsorption. The use temperature can not be higher than 40°C, the

Ordering information

Membrane Material	Pore Size (µm)	Capacity (ml)	Membrane Diameter (mm)	Qty	Product Code
MCE	0,22	150	Ø50	12/Pk	EXVF0150BNC02AZS
	0,22	250	Ø50	12/Pk	EXVF0250BNC02AZS
	0,22	500	Ø75	12/Pk	EXVF0500BNC02BZS
	0,22	1000	Ø91	12/Pk	EXVF1000BNC02CZS
	0,45	150	Ø50	12/Pk	EXVF0150BNC04AZS
	0,45	250	Ø50	12/Pk	EXVF0250BNC04AZS
	0,45	500	Ø75	12/Pk	EXVF0500BNC04BZS
	0,45	1000	Ø91	12/Pk	EXVF1000BNC04CZS
PES	0,1	150	Ø50	12/Pk	EXVF0150BPS01AZS
	0,1	250	Ø50	12/Pk	EXVF0250BPS01AZS
	0,1	500	Ø75	12/Pk	EXVF0500BPS01BZS
	0,1	1000	Ø91	12/Pk	EXVF1000BPS01CZS
	0,22	150	Ø50	12/Pk	EXVF0150BPS02AZS
	0,22	250	Ø50	12/Pk	EXVF0250BPS02AZS
	0,22	250	Ø75	12/Pk	EXVF0250BPS02BZS
	0,22	500	Ø75	12/Pk	EXVF0500BPS02BZS
	0,22	1000	Ø91	12/Pk	EXVF1000BPS02CZS
	0,45	150	Ø50	12/Pk	EXVF0150BPS04AZS
	0,45	250	Ø50	12/Pk	EXVF0250BPS04AZS
	0,45	250	Ø75	12/Pk	EXVF0250BPS04BZS
0,45	500	Ø75	12/Pk	EXVF0500BPS04BZS	
0,45	1000	Ø91	12/Pk	EXVF1000BPS04CZS	
PVDF	0,1	150	Ø50	12/PK	EXVF0150BPV01AZS
	0,1	250	Ø50	12/PK	EXVF0250BPV01AZS
	0,1	500	Ø75	12/PK	EXVF0500BPV01BZS
	0,1	1000	Ø91	12/PK	EXVF1000BPV01CZS
	0,22	150	Ø50	12/PK	EXVF0150BPV02AZS
	0,22	250	Ø50	12/PK	EXVF0250BPV02AZS
	0,22	500	Ø75	12/PK	EXVF0500BPV02BZS
	0,22	1000	Ø91	12/PK	EXVF1000BPV02CZS
PES Hi-Flo	0,45	150	Ø50	12/PK	EXVF0150BPV04AZS
	0,45	250	Ø50	12/PK	EXVF0250BPV04AZS
	0,45	500	Ø75	12/PK	EXVF0500BPV04BZS
	0,45	1000	Ø91	12/PK	EXVF1000BPV04CZS

optimum pH range is 3-6. Particle analysis, particle removal, biochemical analysis, HPLC sample preparation for general media and aqueous solutions.

Can not be used to filter ethanol and alkaline solution.

NY (Nylon)

Providing a broad range of chemical compatibility of the filtration of either aqueous or organic solvents, hydrophilic, can be used in a broad pH range.

PVDF (Polyvinylidene fluoride)

Extremely low protein-binding, for filtration of non-aggressive aqueous and mild organic solutions, or where maximizing protein recovery is important.

PES (Polyethersulfone)

Low-affinity for proteins and extractable with substantially faster flow rates than PVDF; suitable for pre-filtration and filtration of buffers and culture media.

CA (Cellulose Acetate)

Lowest binding material available Hydrophilic and high throughput Strength and dimension stability Uniform pore structure.

Membrane Material	Pore Size (µm)	Capacity (ml)	Membrane Diameter (mm)	Qty	Product Code
Nylon	0,22	150	Ø50	12/PK	EXVF0150BNY02AZS
	0,22	250	Ø50	12/PK	EXVF0250BNY02AZS
	0,22	500	Ø75	12/PK	EXVF0500BNY02BZS
	0,22	1000	Ø91	12/PK	EXVF1000BNY02CZS
	0,45	150	Ø50	12/PK	EXVF0150BNY04AZS
	0,45	250	Ø50	12/PK	EXVF0250BNY04AZS
	0,45	500	Ø75	12/PK	EXVF0500BNY04BZS
	0,45	1000	Ø91	12/PK	EXVF1000BNY04CZS
	0,22	150	Ø50	12/PK	EXVF0150BCA02AZS
	0,22	250	Ø50	12/PK	EXVF0250BCA02AZS
CA	0,22	500	Ø75	12/PK	EXVF0500BCA02BZS
	0,22	1000	Ø91	12/PK	EXVF1000BCA02CZS
	0,45	150	Ø50	12/PK	EXVF0150BCA04AZS
	0,45	250	Ø50	12/PK	EXVF0250BCA04AZS
	0,45	500	Ø75	12/PK	EXVF0500BCA04BZS
	0,45	1000	Ø91	12/PK	EXVF1000BCA04CZS
	0,22	150	Ø50	12/PK	EXVF0150BPX02AZS
	0,22	250	Ø50	12/PK	EXVF0250BPX02AZS
	0,22	500	Ø75	12/PK	EXVF0500BPX02BZS
	0,22	1000	Ø91	12/PK	EXVF1000BPX02CZS
PES Hi-Flo	0,45	150	Ø50	12/PK	EXVF0150BPX04AZS
	0,45	250	Ø50	12/PK	EXVF0250BPX04AZS
	0,45	500	Ø75	12/PK	EXVF0500BPX04BZS
	0,45	1000	Ø91	12/PK	EXVF1000BPX04CZS

Sample Preparation

Bottle Top Filter



GVS Bottle Top Filters are very useful in research laboratories for sterilization or laboratory fluid clarification

- Available with 5 membrane sorts of PVDF, PES, MCE, CA and Nylon
- 3 membrane pore sizes of 0.10 µm, 0.22 µm and 0.45 µm
- 4 volume sizes of 150, 250, 500 and 1000ml
- Light weight and heavy wall construction
- Designed wide and easy access bottle mouth for efficiently and stably
- Non-pyrogenic
- Gamma irradiation sterilized
- Packaged in easy peel-to-open plastic bag
- Each individual unit is lot-numbered for easy identification

Membrane Material	Pore Size (µm)	Capacity (ml)	Membrane Diameter (mm)	Qty	Product Code
PES	0.10	150	Ø50	24/PK	EXBT0150BPS01AWS
	0.10	250	Ø50	24/PK	EXBT0250BPS01AWS
	0.10	500	Ø75	24/PK	EXBT0500BPS01BWS
	0.10	1000	Ø91	24/PK	EXBT1000BPS01CWS
	0.22	150	Ø50	24/PK	EXBT0150BPS02AWS
	0.22	250	Ø50	24/PK	EXBT0250BPS02AWS
	0.22	250	Ø75	24/PK	EXBT0250BPS02BWS
	0.22	500	Ø75	24/PK	EXBT0500BPS02BWS
	0.22	1000	Ø91	24/PK	EXBT1000BPS02CWS
	0.45	150	Ø50	24/PK	EXBT0150BPS04AWS
	0.45	250	Ø50	24/PK	EXBT0250BPS04AWS
	0.45	250	Ø75	24/PK	EXBT0250BPS04BWS
0.45	500	Ø75	24/PK	EXBT0500BPS04BWS	
0.45	1000	Ø91	24/PK	EXBT1000BPS04CWS	
PVDF	0.10	150	Ø50	24/PK	EXBT0150BPV01AWS
	0.10	250	Ø50	24/PK	EXBT0250BPV01AWS
	0.10	500	Ø75	24/PK	EXBT0500BPV01BWS
	0.10	1000	Ø91	24/PK	EXBT1000BPV01CWS
	0.22	150	Ø50	24/PK	EXBT0150BPV02AWS
	0.22	250	Ø50	24/PK	EXBT0250BPV02AWS
	0.22	500	Ø75	24/PK	EXBT0500BPV02BWS
	0.22	1000	Ø91	24/PK	EXBT1000BPV02CWS
	0.45	150	Ø50	24/PK	EXBT0150BPV04AWS
	0.45	250	Ø50	24/PK	EXBT0250BPV04AWS
	0.45	500	Ø75	24/PK	EXBT0500BPV04BWS
	0.45	1000	Ø91	24/PK	EXBT1000BPV04CWS

Membrane Material	Pore Size (µm)	Capacity (ml)	Membrane Diameter (mm)	Qty	Product Code	
MCE	0.22	150	Ø50	24/PK	EXBT0150BNC02AWS	
	0.22	250	Ø50	24/PK	EXBT0250BNC02AWS	
	0.22	500	Ø75	24/PK	EXBT0500BNC02BWS	
	0.22	1000	Ø91	24/PK	EXBT1000BNC02CWS	
	0.45	150	Ø50	24/PK	EXBT0150BNC04AWS	
	0.45	250	Ø50	24/PK	EXBT0250BNC04AWS	
	0.45	500	Ø75	24/PK	EXBT0500BNC04BWS	
	0.45	1000	Ø91	24/PK	EXBT1000BNC04CWS	
	PES Hi-Flu	0.22	150	Ø50	24/PK	EXBT0150BPX02AWS
		0.22	250	Ø50	24/PK	EXBT0250BPX02AWS
		0.22	500	Ø75	24/PK	EXBT0500BPX02BWS
		0.22	1000	Ø91	24/PK	EXBT1000BPX02CWS
0.45		150	Ø50	24/PK	EXBT0150BPX04AWS	
0.45		250	Ø50	24/PK	EXBT0250BPX04AWS	
0.45		500	Ø75	24/PK	EXBT0500BPX04BWS	
0.45		1000	Ø91	24/PK	EXBT1000BPX04CWS	
Nylon		0.22	150	Ø50	24/PK	EXBT0150BNY02AWS
		0.22	250	Ø50	24/PK	EXBT0250BNY02AWS
		0.22	500	Ø75	24/PK	EXBT0500BNY02BWS
		0.22	1000	Ø91	24/PK	EXBT1000BNY02CWS
	0.45	150	Ø50	24/PK	EXBT0150BNY04AWS	
	0.45	250	Ø50	24/PK	EXBT0250BNY04AWS	
	0.45	500	Ø75	24/PK	EXBT0500BNY04BWS	
	0.45	1000	Ø91	24/PK	EXBT1000BNY04CWS	
	CA	0.22	150	Ø50	24/PK	EXBT0150BCA02AWS
		0.22	250	Ø50	24/PK	EXBT0250BCA02AWS
		0.22	500	Ø75	24/PK	EXBT0500BCA02BWS
		0.22	1000	Ø91	24/PK	EXBT1000BCA02CWS
0.45		150	Ø50	24/PK	EXBT0150BCA04AWS	
0.45		250	Ø50	24/PK	EXBT0250BCA04AWS	
0.45		500	Ø75	24/PK	EXBT0500BCA04BWS	
0.45		1000	Ø91	24/PK	EXBT1000BCA04CWS	

Solution Bottle



Capacity(ml)	Sterile	Package	Product Code
150	Yes	24/PK	EXBO0150B000000WS
250	Yes	24/PK	EXBO0250B000000WS
500	Yes	24/PK	EXBO0500B000000WS
1000	Yes	24/PK	EXBO1000B000000WS

Tube Vacuum Filters



Description

150mL Top Vacuum Filter with 50mL centrifuge tube, Sterile

Purpose

Minimizes unnecessary transfers by filtering directly into 50mL centrifuge tube

Materials

Housing: Lid, Cup(GPPS/General Polystyrene);

Connect(ABS/Acrylonitrile-Butadiene-Styrene);

Hose connector(PP/Polypropylene);

Tube: PP(Polypropylene); Cap: HDPE(High-density Polyethylene)

Stand: PP (Polypropylene)

Dimensions (Unit: mm)

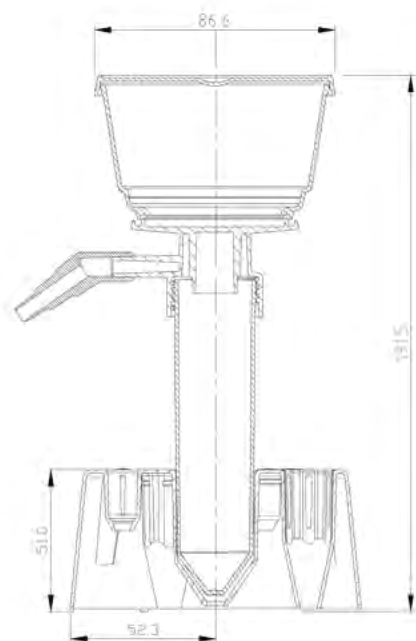

Features

- ◆ Available with 5 membrane types of PVDF, PES, MCE, NYLON, CA
- ◆ 2 pore sizes: 0.22 and 0.45µm
- ◆ Membrane type and pore size printed on unit
- ◆ Tube stand is available with 1.5mL, 2.0mL, 15mL, 50mL conical centrifuge tubes
- ◆ Each polypropylene centrifuge tube is supplied with an individually wrapped cap for storage
- ◆ Designed hose connector can fit multiple hose diameters
- ◆ Effective filtration area of membrane: 15.16cm²
- ◆ Hold-up Volume after purge: ≤3mL
- ◆ DNase/RNase free and Non-pyrogenic
- ◆ Sterilized by irradiation SAL 10⁻⁶ (ISO11137) Shelf Life: 3 years after month of production
- ◆ Manufactured in a class 100,000 clean room environment
- ◆ Manufactured under ISO13485 and ISO9001 quality management system

Membrane Performance Characteristics

Membrane material	PVDF	PVDF	MCE	MCE
Pore size	0.22µm	0.45µm	0.22µm	0.45µm
Average bubble point	56 psi	25 psi	51 psi	31 psi
Flow rate(at 13psi)	7.2mL/min/cm ²	29mL/min/cm ²	18µL/min/cm ²	60µL/min/cm ²

Membrane material	Pore size	Water flow rate (mL/min/cm ² @ 0.7bar, 10psi)	Water bubble point (psi)
PES	0.22µm	19.3~34.6	53.0~69.0
PES	0.45µm	38.0~100.0	36.0~48.0
NYLON	0.22µm	8.07~14.08	40.0~60.0
NYLON	0.45µm	16	29

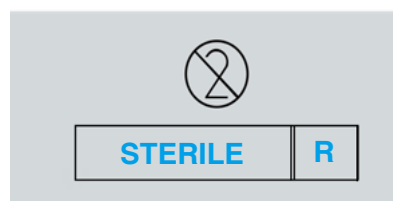

Sample Preparation

Membrane Performance Characteristics

Membrane material	CA	CA
Pore size	0.22µm	0.45µm
Minimum bubble point psi(kg/cm ²)	50 -3.5	30 -2.1
Typical flow rate, mL/min/cm ² @ 10psi (0.7kg/cm ²)	16.1 (-1.13)	54.7 (-3.85)

Tube Top Vacuum Filters

Ordering information

Product Code	Membrane Type	Pore Size	Capacity	Membrane Diameter	Sterilization	Packaging Configuration
EXBU0150BCA04AWS	CA	0.45µm	150mL	ø50mm	Yes	1/bag, 24/case
EXBU0150BCA02AWS	CA	0.22µm	150mL	ø50mm	Yes	1/bag, 24/case
EXBU0150BPS04AWS	PES	0.45µm	150mL	ø50mm	Yes	1/bag, 24/case
EXBU0150BPS02AWS	PES	0.22µm	150mL	ø50mm	Yes	1/bag, 24/case
EXBU0150BNC04AWS	MCE	0.45µm	150mL	ø50mm	Yes	1/bag, 24/case
EXBU0150BNC02AWS	MCE	0.22µm	150mL	ø50mm	Yes	1/bag, 24/case
EXBU0150BPV04AWS	PVDF	0.45µm	150mL	ø50mm	Yes	1/bag, 24/case
EXBU0150BPV02AWS	PVDF	0.22µm	150mL	ø50mm	Yes	1/bag, 24/case
EXBU0150BNY04AWS	NYLON	0.45µm	150mL	ø50mm	Yes	1/bag, 24/case
EXBU0150BNY02AWS	NYLON	0.22µm	150mL	ø50mm	Yes	1/bag, 24/case

Tube Vacuum Filters System

Ordering information

Product Code	Membrane Type	Pore Size	Capacity	Membrane Diameter	Sterilization	Packaging Configuration
EXVS0150BCA04AZS	CA	0.45µm	150mL	ø50mm	Yes	1/bag, 12/case
EXVS0150BCA02AZS	CA	0.22µm	150mL	ø50mm	Yes	1/bag, 12/case
EXVS0150BPS04AZS	PES	0.45µm	150mL	ø50mm	Yes	1/bag, 12/case
EXVS0150BPS02AZS	PES	0.22µm	150mL	ø50mm	Yes	1/bag, 12/case
EXVS0150BNC04AZS	MCE	0.45µm	150mL	ø50mm	Yes	1/bag, 12/case
EXVS0150BNC02AZS	MCE	0.22µm	150mL	ø50mm	Yes	1/bag, 12/case
EXVS0150BPV04AZS	PVDF	0.45µm	150mL	ø50mm	Yes	1/bag, 12/case
EXVS0150BPV02AZS	PVDF	0.22µm	150mL	ø50mm	Yes	1/bag, 12/case
EXVS0150BNY04AZS	NYLON	0.45µm	150mL	ø50mm	Yes	1/bag, 12/case
EXVS0150BNY02AZS	NYLON	0.22µm	150mL	ø50mm	Yes	1/bag, 12/case

Centrifuge Filters - Centrex™



GVS centrifuge filters, Centrex, has various type of membranes and make able the end users to do a larger sample preparation, with a considerable reduction of contamination risk. Thanks to the GVS knowledge in filtration, using Centrex you can reduce the risk of cross contamination.

Characteristics

- Centrifugal filter units with various types of membrane filter
- Rapid and simple preparation of a large number of samples
- Ideal for automated systems and high-speed batch filtration with robots
- Considerably reduced contamination risk when working with radioactive biologically hazardous material
- Cross contamination avoided
- Receiver Tubes 1.5 or 5 mL
- Housing Material Polypropylene

Typical Applications

- 0.45 µm cellulose acetate membrane for the rapid elution of agarose gels
- Nylon 66 and cellulose acetate membranes for the removal of particles and microorganisms from HPLC samples
- Sample preparation for quality control
- Cellulose acetate and nitrocellulose membrane for rapid clearing and filtration of aqueous solutions

Ordering information

Membrane	Pore Size (µm)	Color	1.5 mL Sterile	1.5 mL non-Sterile	5 mL Sterile	5 mL non-Sterile
			50/pk	250/pk	50/pk	250/pk
Nylon 66	0.2	Brown	10467003	-	10467015	10467010
Nylon 66	0.45	Tan	10467007	10467002	10467021	10467012
Cellulose Acetate	0.2	Blue	10467004	10467009	10467013	-
Cellulose Acetate	0.45	White	10467006	10467011	10467017	-
Cellulose Acetate	0.8	Green	10467008	-	-	-
Nitrocellulose	0.2	Pink	10467001	-	-	-
Nitrocellulose	0.45	Rust	10467005	-	10467019	-

Centrifugal Filters



Description

Centrifugal Filters, With 50mL conical tube, PES membrane, Non-sterile.

Purpose

For the centrifugal concentration and purification of biological samples.

Materials

Cap/Sealing gasket: PE (Polyethylene) Color: White

Centrifuge tube: PP (Polypropylene)

Filter: Filter slice (PE/Polyethylene)

Filter tube (MBS/Methyl methacrylate-Butadiene-Styrene);

Membrane: PES (Polyethersulfone)

Features

- Operating temperature range: 0°C - 40°C
- Available in multiple pore sizes with the following defined Molecular Weight Cut-Offs (MWCO): 5, 10, 30, 50 and 100 KD
- Maximum Sample Volume: 15.0 mL (Swinging bucket), 12.0 mL (Fixed angle rotor)
- Final Concentrate Volume: 200 µL
- Fits centrifuges that accept standard 50 mL conical tubes
- Maximum Centrifugal Force: Swinging bucket rotor (3,000 x g), Fixed angle rotor (4,000 x g)
- Active membrane area: 9.7 cm²
- Provides high recoveries more than 80%
- The vertical design and available membrane surface area provide fast sample processing
- Features deadstop to prevent samples from spinning to dryness
- Manufactured in a class 100,000 room environment
- Manufactured under ISO13485 and ISO9001 quality management system

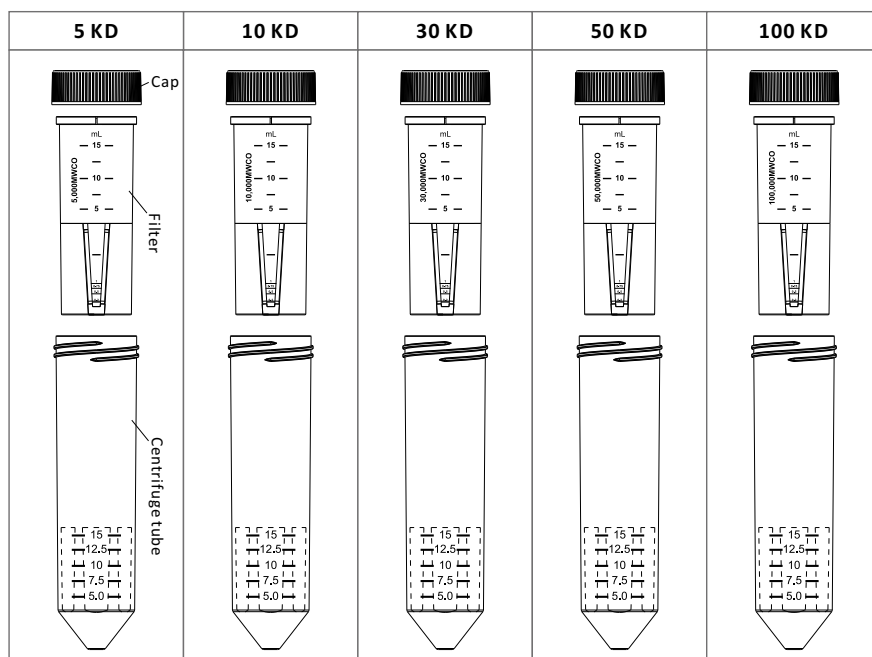

Dimensions(Unit:mm)

Filter device in tube (capped)

Length: 119.5 mm Diameter: 33.7 mm

Filter device

Length: 72.5mm Diameter: 29.3 mm

Sample Preparation

The membrane is not compatible with the following

- Acetic Acid ($\geq 25\%$)
- Acetonitrile ($\geq 30\%$)
- Aliphatic & aromatic esters
- Amines
- Ammonium hydroxide ($\geq 5\%$) Aromatic & chlorinated hydrocarbons Butyl acetate ($\geq 40\%$)
- Dimethyl acetamide (DMAC) ($\geq 30\%$)
- Ethers
- Hydrochloric acid (≥ 0.5 N at 50°C)
- Isopropyl Alcohol ($\geq 25\%$)
- Ketone
- Methylene chloride ($\geq 1\%$)
- Methyl ethyl ketone ($\geq 1\%$)
- Phosphoric acid (≥ 1 N)
- Sodium deoxycholate ($\geq 5\%$)
- Sodium hydroxide (≥ 0.5 N at 50°C) Sodium hypochlorite ($\geq 0.04\%$)
- Tetrahydrofuran ($\geq 5\%$)
- Toluene ($\geq 1\%$)

Ordering information

Product Code	MWCO	Sterilization	Quantity/Box	Quantity/Case
CEF50W003KD08120	3KD	No	8	96
CEF50X003KD24040	3KD	No	24	96
CEF50W005KD08120	5KD	No	8	96
CEF50W005KD24040	5KD	No	24	96
CEF50W010KD08120	10KD	No	8	96
CEF50W010KD24040	10KD	No	24	96
CEF50W030KD08120	30KD	No	8	96
CEF50W030KD24040	30KD	No	24	96
CEF50W050KD08120	50KD	No	8	96
CEF50W050KD24040	50KD	No	24	96
CEF50W100KD08120	100KD	No	8	96
CEF50W100KD24040	100KD	No	24	96

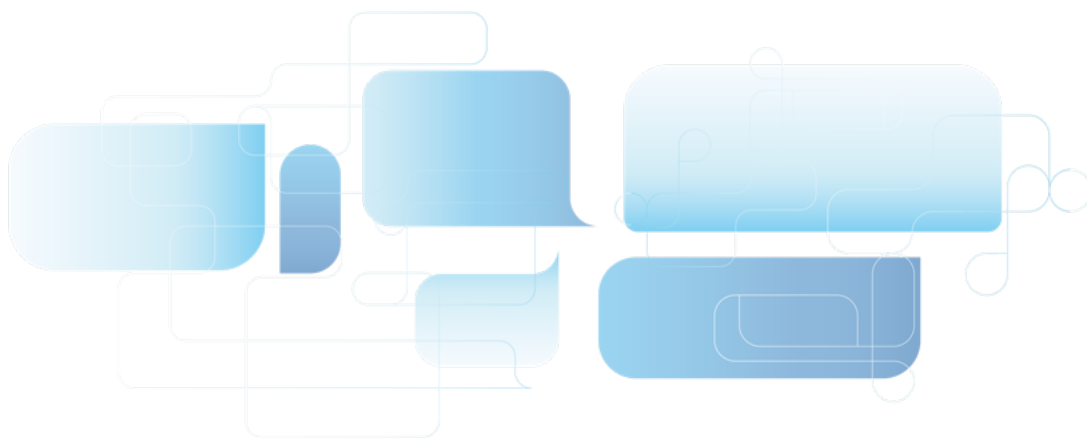

Centrifugal Filters



Description

Centrifugal Filters, With 15mL conical tube, PES membrane, Non-sterile

Purpose

For the centrifugal concentration and purification of biological samples

Materials

Cap/Sealing gasket: PE (Polyethylene) Color: White
 Centrifuge tube: PP (Polypropylene)
 Filter: MBS (Methyl methacrylate-Butadiene-Styrene)
 Membrane: PES (Polyethersulfone)

Features

- Operating temperature range: 0°C - 40°C
- Available in multiple pore sizes with the following defined Molecular Weight Cut-Offs (MWCO): 5, 10, 30, 50 and 100 KD
- Maximum Sample Volume: 5.0 mL
- Final Concentrate Volume: 40-100 μ L
- Fits centrifuges that accept standard 15 mL conical tubes
- Maximum Centrifugal Force: Swinging bucket rotor (3,000 x g), Fixed angle rotor (7,500 x g for 5, 10 KD; 5,000 x g for 30, 50, 100 KD)
- Active membrane area: 3.5 cm²
- Provides high recoveries more than 90%
- The vertical design and available membrane surface area provide fast sample processing
- Features deadstop to prevent samples from spinning to dryness
- Manufactured in a class 100,000 room environment
- Manufactured under ISO13485 and ISO9001 quality management system

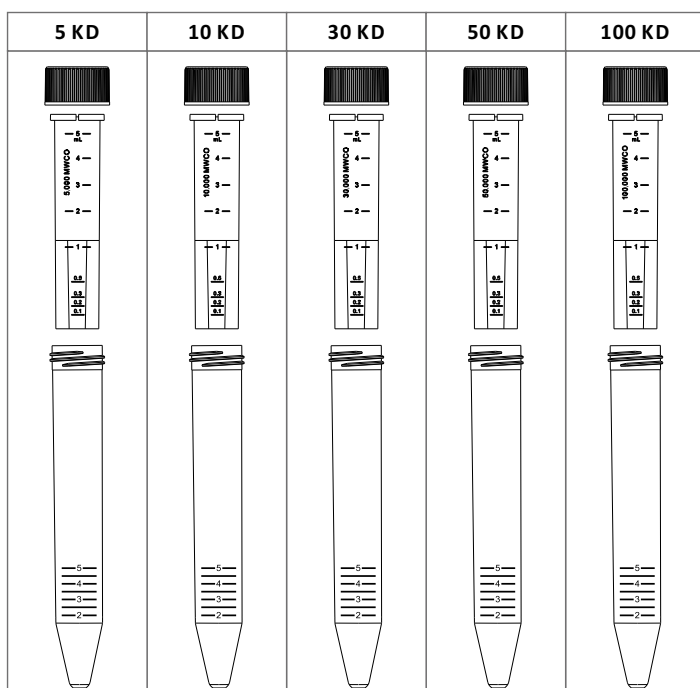

Dimensions(Unit:mm)

Filter device in tube (capped)

Length: 123.4 mm Diameter: 22mm

Filter device

Length: 68mm Diameter: 17.1 mm

Sample Preparation

The membrane is not compatible with the following

- Acetic Acid ($\geq 25\%$)
- Acetonitrile ($\geq 30\%$)
- Aliphatic & aromatic esters
- Amines
- Ammonium hydroxide ($\geq 5\%$)
- Aromatic & chlorinated hydrocarbons
- Butyl acetate ($\geq 40\%$)
- Dimethyl acetamide (DMAC) ($\geq 30\%$)
- Ethers
- Hydrochloric acid (≥ 0.5 N at 50°C)
- Isopropyl Alcohol ($\geq 25\%$)
- Ketone
- Methylene chloride ($\geq 1\%$)
- Methyl ethyl ketone ($\geq 1\%$)
- Phosphoric acid (≥ 1 N)
- Sodium deoxycholate ($\geq 5\%$)
- Sodium hydroxide (≥ 0.5 N at 50°C)
- Sodium hypochlorite ($\geq 0.04\%$)
- Tetrahydrofuran ($\geq 5\%$)
- Toluene ($\geq 1\%$)

Ordering information

Product Code	MWCO	Sterilization	Quantity/Box	Quantity/Case
CEF15W003KD24040	3KD	No	24	96
CEF15W005KD24040	5KD	No	24	96
CEF15W010KD24040	10KD	No	24	96
CEF15W030KD24040	30KD	No	24	96
CEF15W050KD24040	50KD	No	24	96
CEF15W100KD24040	100KD	No	24	96

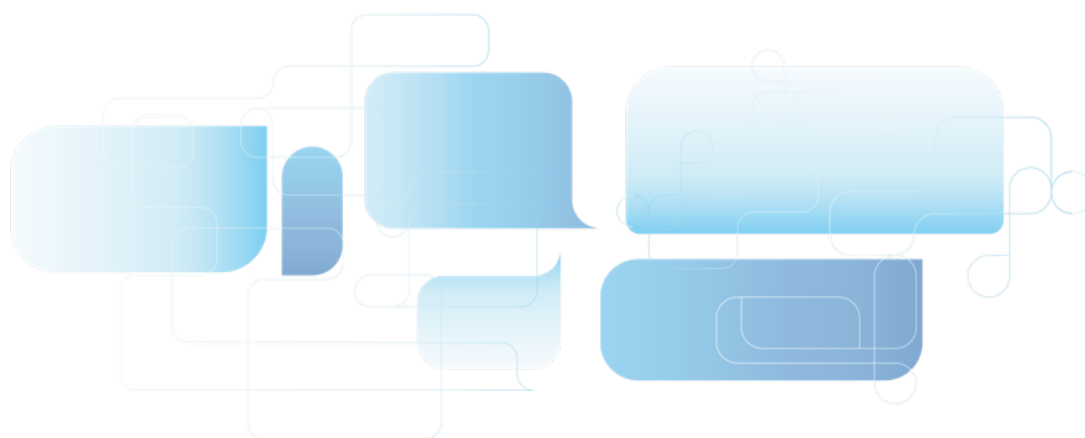

Centrifugal Filters



Features

- Operating temperature range: 0°C - 40°C
- Available in multiple pore sizes with the following defined Molecular Weight Cut-Offs (MWCO): 5, 10, 30, 50 and 100 KD Maximum
- Sample Volume: 500 µL
- Final Concentrate Volume: 20 - 50 µL
- Fits centrifuges that accept standard 2.0 mL conical tubes
- Maximum Centrifugal Force: Fixed angle rotor (7,500 x g)
- Active membrane area: 0.65 cm²
- Provides high recoveries more than 80%
- The vertical design and available membrane surface area provide fast sample processing
- Features deadstop to prevent samples from spinning to dryness
- Manufactured in a class 100,000 room environment
- Manufactured under ISO13485 and ISO9001 quality management system

Description

Centrifugal Filters, With 2.0mL micro centrifuge tube, PES membrane, Non-sterile

Purpose

For the centrifugal concentration and purification of biological samples

Materials

Micro centrifuge tube: PP (Polypropylene)

Filter: MBS (Methyl methacrylate-Butadiene-Styrene)

Membrane: PES (Polyethersulfone)

Dimensions(Unit:mm)

Filter device in tube (capped)

Length: 48.1mm Diameter: 12.9mm

Filter device

Length: 30mm Diameter: 12.6mm

3 KD	5 KD	10 KD	30 KD	50 KD	100 KD

Sample Preparation

The membrane is not compatible with the following

- Acetic Acid ($\geq 25\%$)
- Acetonitrile ($\geq 30\%$)
- Aliphatic & aromatic esters
- Amines
- Ammonium hydroxide ($\geq 5\%$)
- Aromatic & chlorinated hydrocarbons
- Butyl acetate ($\geq 40\%$)
- Dimethyl acetamide (DMAC) ($\geq 30\%$)
- Ethers
- Hydrochloric acid (≥ 0.5 N at 50°C)
- Isopropyl Alcohol ($\geq 25\%$)
- Ketone
- Methylene chloride ($\geq 1\%$)
- Methyl ethyl ketone ($\geq 1\%$)
- Phosphoric acid (≥ 1 N)
- Sodium deoxycholate ($\geq 5\%$)
- Sodium hydroxide (≥ 0.5 N at 50°C)
- Sodium hypochlorite ($\geq 0.04\%$)
- Tetrahydrofuran ($\geq 5\%$)
- Toluene ($\geq 1\%$)

Ordering information

Product Code	MWCO	Sterilization	Quantity/Box	Quantity/Case
CEF02W003KD25120	3KD	No	25	300
CEF02W005KD25120	5KD	No	25	300
CEF02W010KD25120	10KD	No	25	300
CEF02W030KD25120	30KD	No	25	300
CEF02W050KD25120	50KD	No	25	300
CEF02W100KD25120	100KD	No	25	300

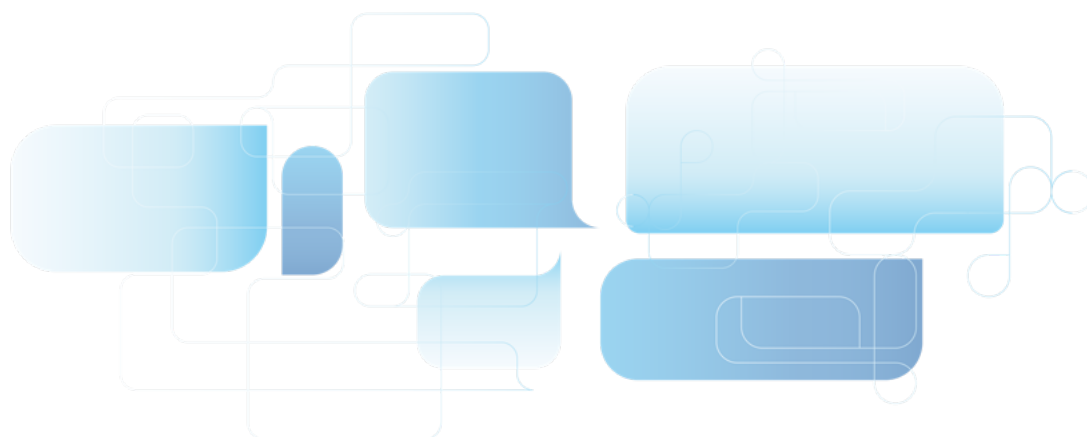

Micro Centrifugal Filter

Features

- Particularly designed for standard benchtop micro centrifuges
- Filter bacteria, particles and cells to prepare HPLC samples, and remove DNA from agarose or acrylamide gels



Ordering information

Product Code	Description	Qty.
MITBYCAH022A	2.0 mL Centrifugal Filters, hydrophilic CA, 0.22 µm	50 Sets/PK
MITBYPVDF022A	2.0 mL Centrifugal Filters, organic PVDF, 0.22 µm	50 Sets/PK
MITBZCAH022A	15 mL Centrifugal Filters, hydrophilic CA, 0.22 µm	50 Sets/PK
MITBZPVDF022A	15 mL Centrifugal Filters, organic PVDF, 0.22 µm	50 Sets/PK
MITBWCAH022A	50 mL Centrifugal Filters, hydrophilic CA, 0.22 µm	50 Sets/PK
MITBWPVDF022A	50 mL Centrifugal Filters, organic PVDF, 0.22 µm	50 Sets/PK
MITBYCAH045A	2.0 mL Centrifugal Filters, hydrophilic CA, 0.45 µm	50 Sets/PK
MITBYPVDF045A	2.0 mL Centrifugal Filters, organic PVDF, 0.45 µm	50 Sets/PK
MITBZCAH045A	15 mL Centrifugal Filters, hydrophilic CA, 0.45 µm	50 Sets/PK
MITBZPVDF045A	15 mL Centrifugal Filters, organic PVDF, 0.45 µm	50 Sets/PK
MITBWCAH045A	50 mL Centrifugal Filters, hydrophilic CA, 0.45 µm	50 Sets/PK
MITBWPVDF045A	50 mL Centrifugal Filters, organic PVDF, 0.45 µm	50 Sets/PK
MITBYMCE022A	2mL Centrifugal Filters, MCE, 0.22µm	50 Sets/PK
MITBYMCE045A	2mL Centrifugal Filters, MCE, 0.45µm	50 Sets/PK
MITBYNY022A	2mL Centrifugal Filters, Nylon, 0.22µm	50 Sets/PK
MITBYNY045A	2mL Centrifugal Filters, Nylon, 0.45µm	50 Sets/PK
MITBYPESH022A	2mL Centrifugal Filters, Hydrophilic PES, 0.22µm	50 Sets/PK
MITBYPTFE022A	2mL Centrifugal Filters, PTFE, 0.22µm	50 Sets/PK
MITBYPTFE045A	2mL Centrifugal Filters, PTFE, 0.45µm	50 Sets/PK
MITBYPTFEH022A	2mL Centrifugal Filters, Hydrophilic PTFE, 0.22µm	50 Sets/PK
MITBYPTFEH045A	2mL Centrifugal Filters, Hydrophilic PTFE, 0.45µm	50 Sets/PK
MITBYPVDFH022A	2mL Centrifugal Filters, Hydrophilic PVDF, 0.22µm	50 Sets/PK
MITBYPVDFH045A	2mL Centrifugal Filters, Hydrophilic PVDF, 0.45µm	50 Sets/PK
MITBYCAH022SA	2mL Centrifugal Filters, Hydrophilic CA, 0.22µm, sterile	50 Sets/PK
MITBYMCE022SA	2mL Centrifugal Filters, MCE, 0.22µm, sterile	50 Sets/PK
MITBYNY022SA	2mL Centrifugal Filters, Nylon, 0.22µm, sterile	50 Sets/PK
MITBYNY045SA	2mL Centrifugal Filters, Nylon, 0.45µm, sterile	50 Sets/PK
MITBYPVDF022SA	2mL Centrifugal Filters, PVDF, 0.22µm, sterile	50 Sets/PK
MITBYPTFEH022SA	2mL Centrifugal Filters, Hydrophilic PTFE, 0.22µm, sterile	50 Sets/PK
MITBYPTFEH045SA	2mL Centrifugal Filters, Hydrophilic PTFE, 0.45µm, sterile	50 Sets/PK
MITBZPESH022A	15mL Centrifugal Filters, Hydrophilic PES, 0.22µm	50 Sets/PK
MITBZPVDFH022A	15mL Centrifugal Filters, Hydrophilic PVDF, 0.22µm	50 Sets/PK
MITBZPVDFH045A	15mL Centrifugal Filters, Hydrophilic PVDF, 0.45µm	50 Sets/PK
MITBZCAH022SA	15mL Centrifugal Filters, Hydrophilic CA, 0.22µm, sterile	50 Sets/PK
MITBZPVDF022SA	15mL Centrifugal Filters, PVDF, 0.22µm, sterile	50 Sets/PK
MITBWMCE045A	50mL Centrifugal Filters, MCE, 0.45µm	50 Sets/PK
MITBWNL045A	50mL Centrifugal Filters, Nylon, 0.45µm	50 Sets/PK
MITBWPESH022A	50mL Centrifugal Filters, Hydrophilic PES, 0.22µm	50 Sets/PK
MITBWPTEFH022A	50mL Centrifugal Filters, Hydrophilic PTFE, 0.22µm	50 Sets/PK
MITBWPTEFH045A	50mL Centrifugal Filters, Hydrophilic PTFE, 0.45µm	50 Sets/PK
MITBWPVDFH022A	50mL Centrifugal Filters, Hydrophilic PVDF, 0.22µm	50 Sets/PK
MITBWPVDFH045A	50mL Centrifugal Filters, Hydrophilic PVDF, 0.45µm	50 Sets/PK
MITBWPVDF022SA	50mL Centrifugal Filters, PVDF, 0.22µm, sterile	50 Sets/PK

Note: Please contact us for more specifications.

Bottle-top Filters - ZapCap™



GVS Bottle-top Filters is ideal solution for the filtration of cell culture media and HPLC media solution. ZapCap is a complete 500 mL filtration unit to connect with receiver bottles. ZapCap are equipped with side tubing nozzle (bottle-top). This ready to use filter is available with prefilter too. The connection seals fit on any standard bottle 33 to 45 mm and the membrane diameter is 76 mm with an effective area of filtration of 39.2 cm². Can be used up to 50°C.

ZapCap™ Selection Guide

ZapCap-S with included package of 12 glass fiber prefilter for high flow rates

ZapCap-S Plus with a glass fiber prefilter for very high flow rates already inserted into the housing.

ZapCap-CR, the chemical-resistant bottle-top filter

Typical Applications

ZapCap-S - Filtration of cell culture media

Cellulose acetate membrane filters (CA) with extremely low protein binding for cell culture media and other aqueous solutions. Sterile filtration of solutions that cannot be autoclaved

ZapCap-S Plus - Sterile filtration and clarification of difficult-to-filter aqueous solutions

ZapCap-CR - Filtration of HPLC solutions

Polyamide Nylon 66 membrane filters (NY) for the retention of particles $\geq 0.2 \mu\text{m}$ in HPLC/FPLC solutions when the column packing is $\leq 10 \mu\text{m}$

PTFE membrane filters for the retention of particles $\geq 0.45 \mu\text{m}$ in organic solutions; strong acids or aldehydes

Ordering information

Membrane Material	Pore Size (μm)	Housing Material	Description	Quantity	Product Code
Cellulose Acetate	0.2	Polystyrene	ZapCap-S / Sterile	12/pk	10443401
Cellulose Acetate	0.45	Polystyrene	ZapCap-S / Sterile	12/pk	10443411
Cellulose Acetate with glass fiber prefilter	0.2	Polystyrene	ZapCap-S PLUS / Sterile	12/pk	10443430
Cellulose Acetate with glass fiber prefilter	0.45	Polystyrene	ZapCap-S PLUS / Sterile	12/pk	10443435
Nylon 66	0.2	Polypropylene	ZapCap-CR / Non Sterile	12/pk	10443421
Nylon 66	0.45	Polypropylene	ZapCap-CR / Non Sterile	12/pk	10443423
PTFE	0.45	Polypropylene	ZapCap-CR / Non Sterile	12/pk	10443425

Extractor - Ethidium bromide (EtBr) waste reduction system

Extractor



One-step filtration polypropylene funnel device for the rapid removal of ethidium bromide from gel-staining solutions. This disposable unit contains an activated carbon matrix, which removes > 99% of ethidium bromide from electrophoretic buffer quickly and easily. Each device can decontaminate up to 10 litres of gel-staining solution. After filtration, the decontaminated solution can be safely poured down the laboratory drain. The extractor funnel device fits most standard laboratory flasks and bottles (neck size 33 to 45 mm), and the unit includes a cap for storage between uses. The polypropylene housing is chemically resistant to organics. Also included in the package are glass fiber prefilters, which remove gel pieces and other debris to avoid premature clogging of the carbon filter.

Ordering information

Product Code	Quantity	Description
10448030	2/pk	Ethidium Bromide Extractor Waste System, Polypropylene
10448031	6/pk	Ethidium Bromide Extractor Waste System, Polypropylene

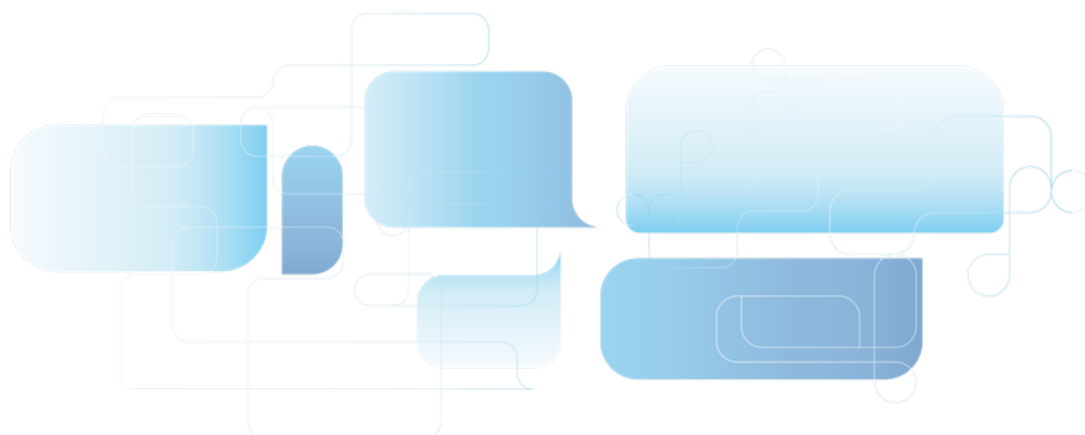

Filter Holders for Membranes

GVS offers a selection of filtration holders and apparatus that are designed to ensure precise filtration work with GVS membranes. In most applications, the filter holder is just as important as the filter for accurate results every time. Filter holders are available for a wide variety of applications including air analysis, chemotaxis, tissue culturing and general aqueous and solvent filtration.

Available products are: 13, 25, and 47 mm Filter Holder, and 47 mm Gravi-Seal.

Product Selection Guide: Filter Holders

Specifications	13 mm	25 mm	47 mm
Materials	Celcon (acetal copolymer)	Polypropylene - body & support	Polypropylene - body & support
O-rings	PTFE	Silicone	Silicone
Filter Size	13 mm	25 mm	47 mm
Prefilter Cap size	10 mm	21 mm	42 mm
Filtration Area	0.8 cm ²	3.5 cm ²	13.5 cm ²
Diameter	16 mm (0.6 in)	30 mm (1.2 in)	65.0 mm (2.6 in)
Height	35 mm (1.4 in)	30 mm (1.2 in)	50 mm (2.0 in)
Maximum Liquid Temperature	80°C (176°F)	80°C (176°F)	80°C (176°F)
Differential Pressure	2.8 bar (40 psi)	2.9 bar (42 psi)	4.9 bar (71 psi)
Autoclaving	15 minutes at 121°C (250°F) and 15 psi	20 minutes at 121°C (250°F) and 15 psi	20 minutes at 121°C (250°F) and 15 psi
Connections, Inlet	Female Luer Lock	Female Luer Lock	1/4 inch NPTM, Female Luer Slip
Connections, Outlet	Male Luer Slip	Male Luer Slip	1/4 inch NPTM, Female Luer Slip

13 mm Filter Holder, Swinney

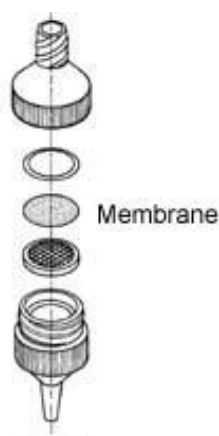

The GVS Swinney 13 mm filter holder is optimized for small volume (1-5 mL) particulate removal from fluids dispensed with a syringe. The holder is resistant to alcohols, esters, ethers, glycols, aromatic hydrocarbons, halogenated hydrocarbons, ketones, oils, photoresists and many other chemicals. Although suitable for most weak acids and bases, we recommend that you test for compatibility with acids.

Features & Benefits

- ◆ High resistant organic components
- ◆ No need for specific tools
- ◆ Quick efficient assembly

Typical Applications

- ◆ Biofluids
- ◆ Ophthalmics
- ◆ Gas chromatography samples
- ◆ Lubricants

Ordering information

Product Code	Quantity	Description
1220950	5/pk	Filter Holder, Swinney, 13 mm diameter

Sample Preparation

25 mm Filter Holder, Polypropylene



The GVS polypropylene 25 mm filter holders are very useful for ultra cleaning and sterilizing small volumes of liquids from a syringe. Due to the polypropylene construction, they can be used over a wide temperature range with excellent chemical compatibility. In the case of the syringe, the inlet cap locks into the base to prevent twisting damage to the membrane as the cap is tightened. Projection lugs on the base and the cap allow these units to be assembled and sealed quickly and efficiently.

Ordering information

Product Code	Quantity	Description
1214250	10/pk	Device Holder, 25mm
1214526	10/pk	Screen Support Holder, 25mm

Typically, the 25 mm is used to filter up to 50 mL of sample. With the syringe holder type, dual support screens prevent membrane rupture in case back pressure is applied.

It also allows for bi-directional sample flow. The polypropylene holder has a broad chemical compatibility range. It can withstand temperatures up to 121°C. and be autoclaved.

Features & Benefits

- Excellent chemical compatibility
- Quick, efficient assembly
- No need for special tools
- Excellent temperature and chemical resistance
- Several filter holders can be attached together for serial filtration

Typical Applications

- Point of use sampling
- Particulate removal
- Used in filtering chromatography solvents
- General filtration

47 mm Filter Holder, Polypropylene



The GVS polypropylene 47 mm filter holder is designed especially for ultra cleaning and sterilizing liquids under positive pressure. In addition this holder can be used for aseptic sampling of liquids or gases at point-of-use or when samples must be collected and processed on-site. The polypropylene material allows these holders to be used over a wide temperature range with excellent chemical compatibility. Sealing is achieved by simple hand

Ordering information

Product Code	Quantity	Description
1262579	1/pk	Filter Holder Polypropylene, 47 mm
1214260	10/pk	Filter Holder Polypropylene, 47 mm

tightening of the locking ring. The 47 mm In-Line holder has dual support screens, which allow for flow in either direction. The inlet cap design and exterior locking ring allow the unit to be assembled quickly and efficiently without tearing the membrane. 3 O-rings help to prevent leaks with all membranes. The 47 mm can filter up to 1 liter depending upon the viscosity of the sample. The polypropylene holder can withstand temperatures up to 121°C and be autoclaved.

Features & Benefits

- Easy to use - unique lock ring design assures proper sealing without damage to the membrane
- Easy to clean
- Conforms with EPA Method 1311 for Toxicity Characteristic Leaching Procedure, 40 CFR, Part 261, 1991 Hazardous Waste Compliance Guide

Typical Applications

- Point of use sampling
- Particulate removal
- Used in filtering chromatography solvents
- General filtration

Sample Preparation

24-Well Micro-Filter Plates

High capacity (up to 7 mL) meets the requirements of receptor binding analysis, protein binding determination, ELISPOT analysis, sample preparation, removal of fluorescent dyes, etc.

Features

- No dead volume, high recovery
- Removable Guide plate and unique designed filter plate
- Use with negative pressure or centrifugal method
- Corresponding collection plate

Ordering information

Product Code	Description	Qty.
MIFPB24PESH022A	24-Well Micro-Filter Plate, 7ml, PES, 0.22 µm, and a collection plate	2 Sets/PK
MIFPB24PVDF022A	24-Well Micro-Filter Plate, 7ml, PVDF, 0.22 µm, and a collection plate	2 Sets/PK
MIFPB24PVDF045A	24-Well Micro-Filter Plate, 7ml, PVDF, 0.45 µm, and a collection plate	2 Sets/PK
MIFPB24MCE022A	24-Well Micro-Filter Plate, 7ml, MCE, 0.22 µm, and a collection plate	2 Sets/PK
MIFPB24MCE045A	24-Well Micro-Filter Plate, 7ml, MCE, 0.45 µm, and a collection plate	2 Sets/PK
MIFPB24NY022A	24-well Micro filter Plates, 7mL, NY, 0.22µm,	2 Sets/PK
MIFPB24MCE022SA	24-well Micro filter Plates, 7mL, MCE, 0.22µm, sterile	2 Sets/PK
MIFPB24NY022SA	24-well Micro filter Plates, 7mL, NY, 0.22µm, sterile	2 Sets/PK
MIFPB24PES022SA	24-well Micro filter Plates, 7mL, PES, 0.22µm, sterile	2 Sets/PK
MIFPB24PESB022A	24-well Micro filter Plates, 7mL, upgraded Hydrophilic PES, 0.22µm, sterile	2 Sets/PK
MIFPB24PTFEH022SA	24-well Micro filter Plates, 7mL, Hydrophilic PTFE, 0.22µm, sterile	2 Sets/PK

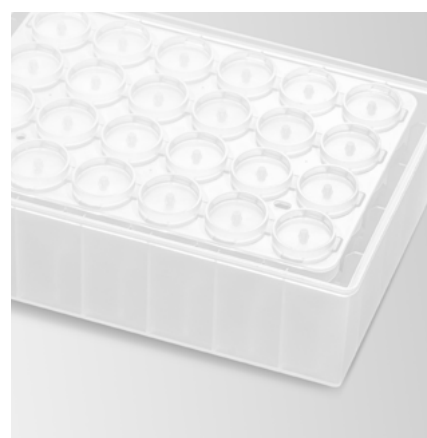

96-Well Micro-Filter Plates



GVS 96-Well Micro-Filter Plates (50-250 µL) are precision injection molded of polystyrene and equipped with many different types and materials of filter membranes, such as polyvinylidene fluoride (PVDF), mixed cellulose (MCE), polytetrafluoroethylene (PTFE) and other microporous filter membranes. Seamless integration is achieved by individually sealed well and removable guide plate and collection plate.

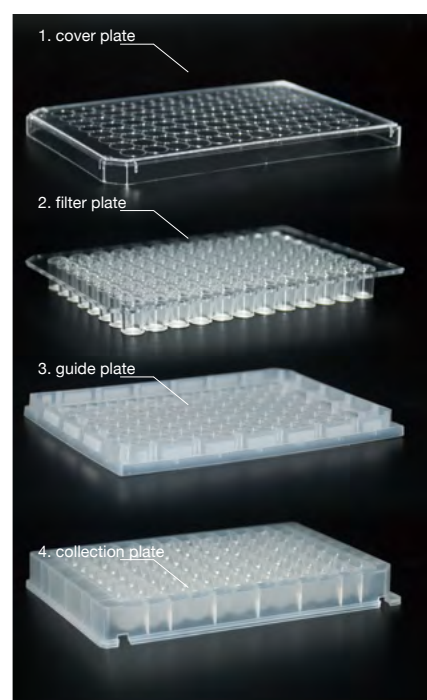

96-Well Micro-Filter Plates

Ordering information

Product Code	Description	Qty.
MIFPB96MCE045A	96-Well Micro-Filter Plates, removable, hydrophilic MCE, 0.45 µm	10 Pcs/PK
MIFPB96MCE022A	96-Well Micro-Filter Plates, removable, hydrophilic MCE, 0.22 µm	10 Pcs/PK
MIFPB96PVDF045A	96-Well Micro-Filter Plates, removable, hydrophobic PVDF, 0.45 µm	10 Pcs/PK
MIFPB96PVDF022A	96-Well Micro-Filter Plates, removable, hydrophobic PVDF, 0.22 µm	10 Pcs/PK
MIFPB96PVDFH045A	96-Well Micro-Filter Plates, removable, hydrophilic PVDF, 0.45 µm	10 Pcs/PK
MIFPB96PVDFH022A	96-Well Micro-Filter Plates, removable, hydrophilic PVDF, 0.22 µm	10 Pcs/PK
MIFPB96PTFE045A	96-Well Micro-Filter Plates, removable, hydrophobic PTFE, 0.45 µm	10 Pcs/PK
MIFPB96PTFE022A	96-Well Micro-Filter Plates, removable, hydrophobic PTFE, 0.22 µm	10 Pcs/PK
MIFPB96PTFEH045A	96-Well Micro-Filter Plates, removable, hydrophilic PTFE, 0.45 µm	10 Pcs/PK
MIFPB96PTFEH022A	96-Well Micro-Filter Plates, removable, hydrophilic PTFE, 0.22 µm	10 Pcs/PK
MIFPBN96CA022A	96-Well Micro-Filter Plate, nonremovable, hydrophilic CA, 0.22 µm	10 Pcs/PK
MIFPBN96CA045A	96-Well Micro-Filter Plate, nonremovable, hydrophilic CA, 0.45 µm	10 Pcs/PK
MIFPBN96MCE022A	96-Well Micro-Filter Plate, nonremovable, hydrophilic MCE, 0.22 µm	10 Pcs/PK
MIFPBN96MCE045A	96-Well Micro-Filter Plate, nonremovable, hydrophilic MCE, 0.45 µm	10 Pcs/PK
MIFPBN96NY022A	96-Well Micro-Filter Plate, nonremovable, hydrophilic Nylon, 0.22 µm	10 Pcs/PK
MIFPBN96NY045A	96-Well Micro-Filter Plate, nonremovable, hydrophilic Nylon, 0.45 µm	10 Pcs/PK
MIFPBN96PES022A	96-Well Micro-Filter Plate, nonremovable, hydrophilic PES, 0.22 µm	10 Pcs/PK
MIFPBN96PTFE022A	96-Well Micro-Filter Plate, nonremovable, hydrophobic PTFE, 0.22 µm	10 Pcs/PK
MIFPBN96PTFE045A	96-Well Micro-Filter Plate, nonremovable, hydrophobic PTFE, 0.45 µm	10 Pcs/PK
MIFPBN96PTFEH022A	96-Well Micro-Filter Plate, nonremovable, hydrophilic PTFE, 0.22 µm	10 Pcs/PK
MIFPBN96PTFEH045A	96-Well Micro-Filter Plate, nonremovable, hydrophilic PTFE, 0.45 µm	10 Pcs/PK
MIFPBN96PVDF022A	96-Well Micro-Filter Plate, nonremovable, hydrophobic PVDF, 0.22 µm	10 Pcs/PK
MIFPBN96PVDF045A	96-Well Micro-Filter Plate, nonremovable, hydrophobic PVDF, 0.45 µm	10 Pcs/PK
MIFPBN96PVDF045SA	96-Well Micro-Filter Plate, nonremovable, hydrophobic PVDF, 0.45 µm, sterile	10 Pcs/PK
MIFPB96NY022A	96-well Micro filter Plates, 300µL, NY, 0.22µm,	10 Pcs/PK
MIFPB96NY045A	96-well Micro filter Plates, 300µL, NY, 0.45µm,	10 Pcs/PK
MIFPB96PESH022A	96-well Micro filter Plates, 300µL, Hydrophilic PES, 0.22µm,	10 Pcs/PK
MIFPB96MCE022SA	96-well Micro filter Plates, 300µL, MCE, 0.22µm, sterile	10 Pcs/PK
MIFPB96NY022SA	96-well Micro filter Plates, 300µL, NY, 0.22µm, sterile	10 Pcs/PK
MIFPB96PES022SA	96-well Micro filter Plates, 300µL, PES, 0.22µm, sterile	10 Pcs/PK
MIFPB96PTFEH022SA	96-well Micro filter Plates, 300µL, Hydrophilic PTFE, 0.22µm, sterile	10 Pcs/PK
MIFPBN96PVDFH022SA	96-well Micro filter Plates, 300µL, Hydrophilic PVDF, 0.22µm, sterile	10 Pcs/PK
MIFPBN96CA022SA	96-well Micro filter Plates, 300µL, CA, 0.22µm, sterile	10 Pcs/PK
MIFPBY96PTFE045A	Integrated 96-well Micro filter Plates, 600µL, PTFE, 0.45µm,	10 Pcs/PK
MIFPBY96PTFEH022A	Integrated 96-well Micro filter Plates, 600µL, Hydrophilic PTFE, 0.22µm,	10 Pcs/PK
MIFPBY96PTFEH045A	Integrated 96-well Micro filter Plates, 600µL, Hydrophilic PTFE, 0.45µm,	10 Pcs/PK

Cannula filters



GVS cannula filters, commonly used in dissolution processes at the ends of the sampling cannula, help keep particulates from backing up into the tubes.

Filters are completely inert to most compounds and provide a good flow rate.

Features:

- Achieve reproducibility and consistency from test to test with GVS dissolution filters
- Keep contaminants out of dissolution samples
- Guaranteed free of chromium and heavy metal
- Made of the highest quality UHMW Sintered Polyethylene for dissolution sampling methods

Characteristics:

- Length: 21,0mm
- Diameter: 9,0mm

Ordering information

Product Code	Description
FSCLBRPE010BUI01	Filter for sampling cannula 1/8" 10um, blue, box with 250 units
FSCLBRPE020GUI01	Filter for sampling cannula 1/8" 20um, green, box with 250 units
FSCLBRPE035RUI01	Filter for sampling cannula 1/8" 35um, red, box with 250 units
FSCLBRPE045PUI01	Filter for sampling cannula 1/8" 45um, purple, box with 250 units
FSCLBRPE070YUI01	Filter for sampling cannula 1/8" 70um, yellow, box with 250 units
FSCLBRPE001WUM01	Filter for sampling cannula 1/8" 1um, white, box with 1000 units
FSCLBRPE001WUI01	Filter for sampling cannula 1/8" 1um, White, box with 250 units

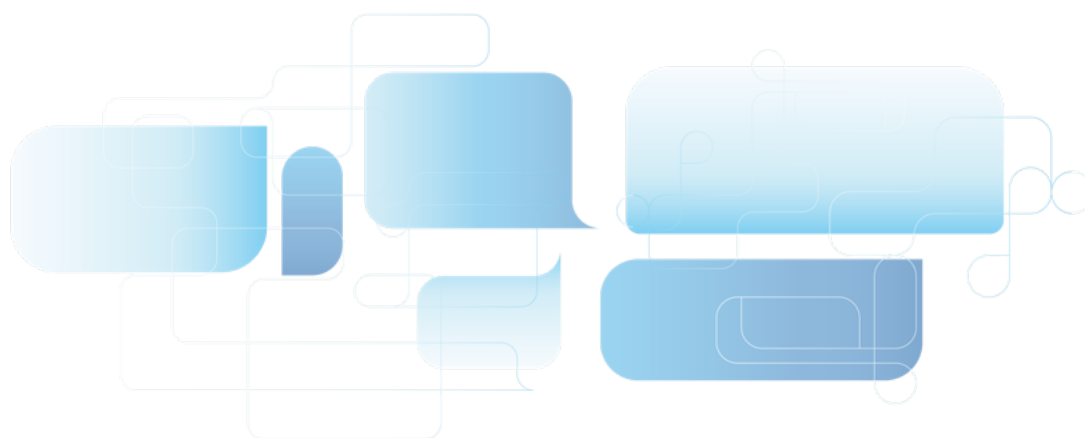

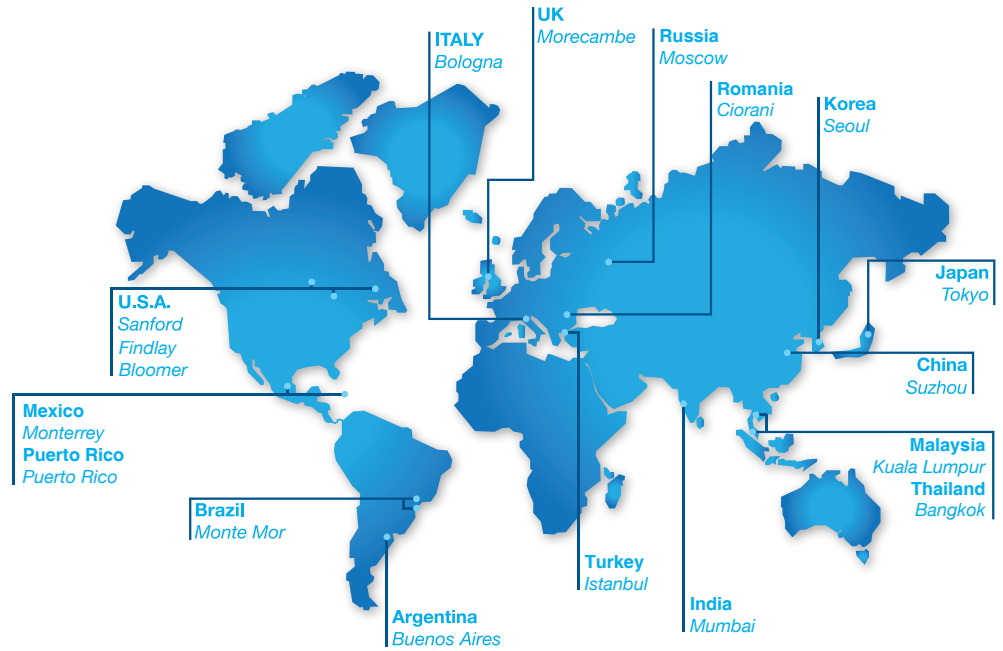

WORLDWIDE

EUROPE

Italy Office
Headquarters
GVS S.p.A.
Via Roma 50
40069 Zola Predosa (BO) - Italy
Tel. +39 051 6176311
gvs@gvs.com

Russia
GVS Russia LLC.
Profsoyuznaya Street, 25-A, office 102
117418, Moscow
Russian Federation (Russia)
Tel. +7 495 0045077
gvsrussia@gvs.com

United Kingdom
GVS Filter Technology UK Ltd.
Caton Road, Lancaster, Lancashire,
LA1 3PE, UK.
Tel. +44 (0) 1524 847600
gvsuk@gvs.com

Romania
GVS Microfiltrazione srl
Sat Ciorani de Sus 1E - Comuna Ciorani
Prahova România
Tel. (+40) 244 463044
gvsro@gvs.com

Türkey
GVS Türkiye
Nidakule Merdivenköy Mahallesi
Bora Sokak No:1 Kat:7 - 34732 Istanbul
Tel. +90 216 504 47 67
gvsturkey@gvs.com

ASIA

China
GVS Technology (Suzhou) Co., Ltd.
No.8 Taishan Road,215129
New District, Suzhou, Jiangsu, China
Tel. +86 512 6661 9880
lifesciences.cn@gvs.com

GVS Shanghai Transfusion Technology Co., Ltd.
No.500 Youdong Rd
40069 Shanghai, China
Tel. +86 21 3415 3961

Japan
GVS Japan K.K.
KKD Building 4F, 7-10-12 Nishishinjuku
Shinjuku-ku, Tokyo 160-0023 Japan
Tel. +81 3 5937 1447
gvsjapan@gvs.com

Korea
GVS Korea Ltd
#315 Bricks Tower
368 Gyungchun-ro(Gaun-dong),
Namyangju-si, Gyunggi-do,
Tel: +82 31 563 9873
gvskorea@gvs.com

India
GVS Filter India Pvt Ltd
Unit No 35 & 36 on First Floor
Patna Jyot Industrial Premises Irla Lane,
Irla Vile Parle, Mumbai 400056, India
gvsindia@gvs.com

Malaysia
GVS Filtration Sdn.Bhd
Lot No 10F-2B, 10th Floor, Tower 5 @ PFCC
Jalan Puteri 1/2, Bandar Puteri
47100 Puchong, Selangor, Malaysia
Tel: +60 3 7800 0062
gvsmalaysia@gvs.com

Thailand
GVS Thailand
88 Ratchadaphisek Rd,
Office 10E03 - Khlong Toei,
Bangkok 10110
gvsthailand@gvs.com

AMERICA

U.S.A.
GVS North America
63 Community Drive
Sanford, ME 04073 - USA
Tel. +1 866 7361250
gvsusa@gvs.com

GVS Filtration Inc.
2150 Industrial Drive
Findlay, OH. 45840 - USA
Tel. +1.419.423.9040
gvsfiltration@gvs.com

2200 W 20th Avenue
Bloomer, WI 54724 - USA
Tel. +1.715.568.5944
gvsfiltration@gvs.com

Puerto Rico
GVS Puerto Rico, LLC
98 Carr 194 - Fajardo,
Puerto Rico, 00738-2988, USA
Tel. +1.787.355.4100
gvspuertorico@gvs.com

México
GVS Filter Technology de Mexico
Universal No. 550, Vynmsa Aeropuerto Apodaca
Industrial Park, Ciudad Apodaca, Nuevo León, C.P.
66626 - México
Tel. +52 81 2282 9003
gvs_mex@gvs.com

Argentina
GVS Argentina S.A.
Avenida Rivadavia 13.332
1704 Ramos Mejia,
Buenos Aires - Argentina
Tel. + 5411 48614750
lifesciences.ar@gvs.com

Brazil
GVS do Brasil Ltda.
Rodovia Conego Cyriaco Scaranello Pires 251
Jardim Chapadão, CEP 13193-580
Monte Mor (SP) - Brasil
Tel. +55 19 38797200
gvs@gvs.com.br

PRODUCT COLLECTION - Sample Preparation

Copyright © 2026 GVS ® S.p.A.
All Right Reserved - Printed in Italy
Printing History: Version 27052026